

# **DECstation 5000 Model 240**

---

Hardware Operator's Guide

---

**First printing, December 1991**

The information in this document is subject to change without notice and should not be construed as a commitment by Digital Equipment Corporation. Digital Equipment Corporation assumes no responsibility for any errors that may appear in this document.

The software described in this document is furnished under a license and may be used or copied only in accordance with the terms of such license.

Digital Equipment Corporation assumes no responsibility for the use or reliability of its software on equipment that is not supplied by Digital or its affiliated companies.

© Digital Equipment Corporation 1991.  
All Rights Reserved  
Printed in U.S.A.

---

U.S.A.

This equipment generates, uses, and may emit radio frequency energy. The equipment has been type tested and found to comply with the limits for a Class A computing device pursuant to Subpart J of Part 15 of FCC Rules, which are designed to provide reasonable protection against such radio frequency interference. Operation of this equipment in a residential area may cause interference in which case the user at his own expense will be required to take whatever measures may be required to correct the interference.

---

The following are trademarks of Digital Equipment Corporation:

DEC	MicroVMS	VAX
DECnet	PDP	VAXBI
DECstation	ThinWire	VAXcluster
DECsystem	TURBOchannel	VAXstation
DECUS	ULTRIX	VMS
DESTA	ULTRIX-32	VT
MicroVAX	UNIBUS	<b>digital</b> <sup>™</sup>

---

# Contents

Using This Guide .....	xiii
------------------------	------

## Part I Introducing Your Workstation

### 1 The Main Components and How to Install Them

The System Unit .....	1-2
Front of the System Unit .....	1-3
Back of the System Unit .....	1-4
Icons on the System Unit .....	1-6
Setting Up the System Unit .....	1-6
The Monitor .....	1-9
Turning Your Monitor On and Off .....	1-9
Positioning the Monitor .....	1-10
Connecting the Monitor Video Cable .....	1-11
To Connect a Color Video Cable .....	1-12
To Connect a Gray-scale Video Cable .....	1-14
To Connect a Monochrome Video Cable .....	1-16
Connecting More Than One Monitor to a Workstation ..	1-17
Supplying Power to the Monitor .....	1-18
To Connect the Monitor to the System Unit Power Outlet .....	1-19
To Connect the Monitor to an Independent Power Outlet .....	1-21
Input Devices .....	1-23

The Keyboard .....	1-23
The LK401 Keyboard .....	1-23
The LK421 keyboard .....	1-24
Connect the Keyboard to the System Unit .....	1-25
To Adjust the Keyboard Feet .....	1-29
Pointing Devices .....	1-30
The Mouse and Tablet .....	1-30
Dial and Button Boxes .....	1-32
Adjusting and Positioning Your Workstation for Comfort ...	1-33

## 2 The Right Environment

Site Requirements .....	2-2
Temperature and Humidity .....	2-2
Cleanliness .....	2-2
Interference .....	2-2
Power .....	2-3
Supplies .....	2-3
Workstation Voltage Requirements .....	2-3

## 3 Starting and Testing

Turning On Your Workstation .....	3-2
Setting the Keyboard Language .....	3-5
Testing Your Workstation .....	3-6
To Specify the Quick or Full Self-Test .....	3-6
How to Run the Full Self-Test at Any Time .....	3-7
If a Self-Test Fails .....	3-7
Checking the Configuration Display .....	3-7
Stopping the Workstation Without Turning It Off .....	3-8
Turning Off the Workstation .....	3-9

## 4 Taking Your Workstation Apart

Dismantling Your Workstation .....	4-2
Packing Your Equipment .....	4-2
Reinstalling Your Workstation .....	4-2

## Part II External Additions to Your Workstation

### 5 External Storage Devices

Storage Devices You Can Add to Your Workstation .....	5-2
Rules for Connecting Storage Devices .....	5-3
Installing External Storage Devices .....	5-4
Checking the Total SCSI Cable Length .....	5-14
Checking and Setting SCSI ID Numbers .....	5-15
To Check the SCSI ID .....	5-15
To Set the SCSI ID .....	5-16
Testing External Storage Devices .....	5-17
Removing an External Storage Device .....	5-19
Installing a Drive in an Expansion Box .....	5-19

### 6 Optional Network Connections

Locating Your Workstation Ethernet Connector .....	6-2
Installing and Removing an Ethernet Loopback Connector .....	6-2
Operating the Ethernet Connector Sliding Lock .....	6-3
Finding Your Ethernet Station Address .....	6-6
Connecting the Workstation to an Ethernet Network .....	6-7
To Connect a ThickWire Ethernet Cable .....	6-8
To Connect a ThinWire Ethernet Adapter .....	6-11
To Connect a Twisted-Pair Ethernet Adapter .....	6-15

### 7 External Communications Options

External Communications Options .....	7-2
Types of Connectors .....	7-3
Installing a Device with a 25-Pin Connector .....	7-4
Installing a Device with a Modular Connector .....	7-6

## Part III Internal Parts and Additions to Your Workstation

### 8 Inside the System Unit

Main Parts of the System Unit .....	8-2
The Base System Module .....	8-3
Memory Modules .....	8-3
Nonvolatile Random-access Memory (NVRAM) Module .....	8-4
The CPU Module .....	8-4
TURBOchannel Option Modules .....	8-4
The Power Supply .....	8-5
Removing and Replacing the System Unit Cover .....	8-6
To Remove the Cover from the System Unit .....	8-6
To Replace the Cover on the System Unit .....	8-7
Using the Antistatic Wrist Strap .....	8-8

### 9 Installing Internal Option Modules

Installing and Removing Memory .....	9-2
To Install Memory Modules .....	9-3
To Test Memory Modules .....	9-7
To Remove Memory Modules .....	9-8
Installing and Removing a PrestoServe/NVRAM Module ...	9-11
Replacing CPU Modules .....	9-14
To Remove a CPU Module .....	9-14
To Install a New CPU Module .....	9-16
To Test the CPU Module .....	9-18
Installing and Removing TURBOchannel Option Modules .....	9-19

## Part IV Managing Your Workstation

### 10 Using the Console Commands

Console and Operating Modes .....	10-2
Using Console Mode .....	10-2
To enter console mode .....	10-3
Console prompts .....	10-3
Installing a Terminal as an Alternate System Console ...	10-4
To Install a Terminal as a System Console .....	10-4

To Activate the Terminal as the System Console .....	10-6
To Make Your Workstation Monitor the System Console .....	10-7
Rules for Typing Console Commands .....	10-8
Conventions Used in This Chapter .....	10-9
Console Commands .....	10-10
?	10-11
boot	10-11
cat	10-12
cnfg	10-13
d	10-17
e	10-18
erl	10-19
go	10-19
init	10-19
ls	10-20
passwd	10-20
printenv	10-21
restart	10-21
script	10-22
setenv	10-22
sh	10-22
t	10-23
unsetenv	10-23
Environment Variables .....	10-24

## 11 Troubleshooting

Where to Look for Which Problem .....	11-2
Contacting Your Customer Support Center .....	11-3
Is It On? .....	11-4
Is It Connected Properly? .....	11-9
Is It Working? .....	11-18
How to Interpret Self-Test Messages .....	11-19

## Part V Appendixes

### A Equipment Specifications

DECstation 5000 Model 240 System Unit Equipment Specifications .....	A-2
LK401-AA Keyboard Equipment Specifications .....	A-3
LK421-AA Keyboard Equipment Specifications .....	A-5
VSXXX-GA Mouse Equipment Specifications .....	A-7
VSXXX-AB Tablet Equipment Specifications .....	A-9
BA42 Storage Expansion Box Equipment Specifications .....	A-11
RZ55 SCSI Hard Disk Drive Equipment Specifications .....	A-12
RZ56 SCSI Hard Disk Drive Equipment Specifications .....	A-14
RZ57 SCSI Hard Disk Drive Equipment Specifications .....	A-16
RZ58 SCSI Hard Disk Drive Equipment Specifications .....	A-18
TK50Z Tape Drive Equipment Specifications .....	A-20
TZ30 Tape Drive Equipment Specifications .....	A-22
TZK10 QIC Tape Drive Equipment Specifications .....	A-24
TLZ04 Cassette Tape Drive Equipment Specifications .....	A-26
RRD42 Compact Disc Drive Equipment Specifications .....	A-27
RX23 Diskette Drive Equipment Specifications .....	A-28
RX33 Diskette Drive Equipment Specifications .....	A-30

### B Part Numbers

### C Connector Pin Assignments

### D Regulatory Information for the UK

Service Requirements .....	D-1
Communication Port Pin Assignments .....	D-2
Approvals for Digital Circuits .....	D-2
Host Independent Approvals .....	D-3
Host Power Rating .....	D-4
Power Supply Characteristics .....	D-4
Dynamic load regulation .....	D-6
DI/DT load steps .....	D-6
Environmental Conditions .....	D-7
Unsupported System Module Ports .....	D-7



# Index

## Figures

1-1	Front of the system unit .....	1-3
1-2	Back of the system unit .....	1-4
1-3	Icons on the system unit .....	1-6
1-4	Attaching a ThickWire Ethernet loopback connector .....	1-7
1-5	Connecting the power cord to the system unit .....	1-8
1-6	Turning off your monitor .....	1-9
1-7	Turning on your monitor .....	1-10
1-8	Video cable assemblies .....	1-11
1-9	Connecting a video cable assembly to a color monitor .....	1-12
1-10	Connecting a color video cable to the system unit .....	1-13
1-11	Connecting a video cable assembly to a gray-scale monitor ..	1-14
1-12	Connecting a grey-scale video cable assembly to the system unit .....	1-15
1-13	Connecting a video cable assembly to a monochrome monitor .....	1-16
1-14	Connecting a monochrome video cable assembly to the system unit .....	1-17
1-15	Monitor-to-system-unit power cable .....	1-19
1-16	Connecting the monitor-to-system-unit power cable .....	1-20
1-17	Monitor power cord .....	1-21
1-18	Connecting a separate monitor power cord .....	1-22
1-19	LK401 keyboard .....	1-23
1-20	LK421 keyboard .....	1-24
1-21	Keyboard-mouse cable assembly .....	1-25
1-22	Connecting the keyboard-mouse cable assembly to the system unit .....	1-26
1-23	Connecting the keyboard cable to the connector block .....	1-27
1-24	Positioning the connector block .....	1-28
1-25	Raising and lowering the hinged feet on the keyboard .....	1-29
1-26	Pointing devices .....	1-30
1-27	Connecting the mouse or tablet .....	1-31
1-28	Dial and button boxes .....	1-32
2-1	Voltage labels .....	2-3
3-1	Turning on the system unit .....	3-3
3-2	Halt button and system unit on/off switch .....	3-8

5-1	Some typical expansion boxes .....	5-2
5-2	Power switch in the off position .....	5-4
5-3	System-unit-to-expansion-box cable .....	5-5
5-4	Connecting the system-unit-to-expansion-box cable to the system unit .....	5-6
5-5	Connecting the system-unit-to-expansion-box cable to expansion box .....	5-7
5-6	SCSI box-to-box cable .....	5-8
5-7	Connecting an additional non-TCE expansion box to the first box .....	5-9
5-8	TCE-to-expansion-box cable .....	5-10
5-9	Connecting the TCE to the expansion box .....	5-11
5-10	Connecting a SCSI drive terminator .....	5-12
5-11	Connecting the power cord .....	5-13
6-1	ThickWire Ethernet loopback connector .....	6-2
6-2	Installing and removing an Ethernet loopback connector .....	6-3
6-3	Unlocking the Ethernet sliding lock .....	6-4
6-4	Locking the Ethernet sliding lock .....	6-5
6-5	ThickWire Ethernet cable .....	6-8
6-6	Connecting a ThickWire Ethernet cable to the system unit .....	6-9
6-7	Parts used to connect a workstation to a ThinWire network .....	6-11
6-8	Connecting a ThickWire cable to the ThinWire adapter .....	6-12
6-9	Attaching a T-connector .....	6-13
6-10	Attaching a T-connector terminator .....	6-14
6-11	Parts used to connect a workstation to a twisted-pair Ethernet network .....	6-15
6-12	Connecting the ThickWire-to-twisted-pair-adapter .....	6-16
6-13	Connecting the twisted-pair cable to the twisted-pair adapter .....	6-17
7-1	Communications connectors on the system unit .....	7-2
7-2	Communications device connectors and an adapter .....	7-3
7-3	Connecting a communications device with a 25-pin connector .....	7-4
7-4	Using an adapter to connect a communications device with a modular connector .....	7-7
8-1	Inside of the system unit enclosure .....	8-2
8-2	Removing and replacing the system unit cover .....	8-7
8-3	Using an antistatic wrist strap .....	8-8
9-1	Releasing the memory module bracket .....	9-4

9-2	Memory module .....	9-5
9-3	Memory slots inside the system unit .....	9-6
9-4	Releasing the memory module bracket .....	9-9
9-5	Removing a memory module .....	9-10
9-6	Typical CPU module .....	9-15
9-7	Installing a CPU module .....	9-16
9-8	Removing the nameplate .....	9-17
10-1	Connecting a VT320 terminal to the system unit .....	10-5
11-1	Indicator light and LED display .....	11-5
D-1	Unsupported ports on the DECstation 5000 Model 240 system module .....	D-7

## Tables

1	Conventions Used in This Guide .....	xiv
1-1	Connectors, Controls, LED Display, and Lights on the System Unit .....	1-5
5-1	SCSI Cable Lengths .....	5-14
5-2	Usual SCSI ID Assignments for External Drives .....	5-15
5-3	SCSI ID Switch Settings .....	5-16
5-4	Device Codes for Different Types of SCSI Drives .....	5-18
10-1	Console Commands .....	10-10
10-2	Module Codes .....	10-14
10-3	SCSI Device Codes and Descriptors .....	10-17
10-4	Console Commands for Environment Variables .....	10-24
10-5	Environment Variables Set by the User .....	10-24
11-1	Interpreting the LED Codes .....	11-6
11-2	Solutions to Common Problems .....	11-9
11-3	Self-Test Error Messages for the Base System Slot .....	11-20
A-1	System Unit Description .....	A-2
A-2	System Unit Operating Conditions .....	A-2
A-3	System Unit Nonoperating Conditions .....	A-2
A-4	LK401-AA Keyboard Description .....	A-3
A-5	LK401-AA Keyboard Operating Conditions .....	A-3
A-6	LK401-AA Keyboard Nonoperating Conditions .....	A-4
A-7	LK421-AA Keyboard Description .....	A-5
A-8	LK421-AA Keyboard Operating Conditions .....	A-5
A-9	LK421-AA Keyboard Nonoperating Conditions .....	A-6
A-10	VSXXX-GA Mouse Description .....	A-7

A-11	VSXXX-GA Mouse Operating Conditions .....	A-7
A-12	VSXXX-GA Mouse Nonoperating Conditions .....	A-8
A-13	VSXXX-AB Tablet Description .....	A-9
A-14	VSXXX-AB Tablet Operating Conditions .....	A-10
A-15	VSXXX-AB Tablet Nonoperating Conditions .....	A-10
A-16	BA42 Storage Expansion Box Description .....	A-11
A-17	BA42 Storage Expansion Box Operating Conditions .....	A-11
A-18	BA42 Storage Expansion Box Nonoperating Conditions .....	A-11
A-19	RZ55 SCSI Hard Disk Drive Description .....	A-12
A-20	RZ55 SCSI Hard Disk Drive Operating Conditions .....	A-13
A-21	RZ55 SCSI Hard Disk Drive Nonoperating Conditions .....	A-13
A-22	RZ56 SCSI Hard Disk Drive Description .....	A-14
A-23	RZ56 SCSI Hard Disk Drive Operating Conditions .....	A-14
A-24	RZ56 SCSI Hard Disk Drive Nonoperating Conditions .....	A-15
A-25	RZ57 SCSI Hard Disk Drive Description .....	A-16
A-26	RZ57 SCSI Hard Disk Drive Operating Conditions .....	A-16
A-27	RZ57 SCSI Hard Disk Drive Nonoperating Conditions .....	A-17
A-28	RZ58 SCSI Hard Disk Drive Description .....	A-18
A-29	RZ58 SCSI Hard Disk Drive Operating Conditions .....	A-18
A-30	RZ58 SCSI Hard Disk Drive Nonoperating Conditions .....	A-19
A-31	TK50Z Tape Drive Description .....	A-20
A-32	TK50Z Tape Drive Operating Conditions .....	A-20
A-33	TK50Z Tape Drive Nonoperating Conditions .....	A-21
A-34	TZ30 Tape Drive Description .....	A-22
A-35	TZ30 Tape Drive Operating Conditions .....	A-22
A-36	TZ30 Tape Drive Nonoperating Conditions .....	A-23
A-37	TZK10 QIC Tape Drive Description .....	A-24
A-38	TZK10 QIC Tape Drive Operating Conditions .....	A-24
A-39	TZK10 QIC Tape Drive Nonoperating Conditions .....	A-25
A-40	TLZ04 Cassette Tape Drive Description .....	A-26
A-41	TLZ04 Cassette Tape Drive Operating Conditions .....	A-26
A-42	TLZ04 Cassette Tape Drive Nonoperating Conditions .....	A-26
A-43	RRD42 Compact Disc Drive Description .....	A-27
A-44	RRD42 Compact Disc Drive Operating Conditions .....	A-27
A-45	RRD42 Compact Disc Drive Nonoperating Conditions .....	A-27
A-46	RX23 Diskette Drive Description .....	A-28
A-47	RX23 Diskette Drive Operating Conditions .....	A-29
A-48	RX23 Diskette Drive Nonoperating Conditions .....	A-29
A-49	RX33 Diskette Drive Description .....	A-30

A-50	RX33 Diskette Drive Operating Conditions .....	A-31
A-51	RX33 Diskette Drive Nonoperating Conditions .....	A-31
B-1	Basic Components .....	B-2
B-2	User-replaceable Modules in the System Unit .....	B-2
B-3	Cords and Cables .....	B-3
B-4	Adapters, Connectors, and Terminators .....	B-4
B-5	Software Documentation .....	B-4
B-6	Hardware Documentation .....	B-5
C-1	SCSI Cable Connector Pin Assignments .....	C-2
C-2	Keyboard and Mouse or Tablet Connector Pin Assignments .....	C-3
C-3	Communications Connectors Pin Assignments .....	C-4
C-4	ThickWire Ethernet Connector Pin Assignments .....	C-5
C-5	Power Supply Pin Assignments .....	C-5
C-6	Modem Loopback Connector Pin Assignments .....	C-6
C-7	Ethernet Loopback Connector Pin Assignments .....	C-6
C-8	Summary of Loopback Connectors .....	C-6
D-1	KN03A-AA service requirements .....	D-1
D-2	Clearance and Creepage Specs for KN03A-AA .....	D-3
D-3	Module Power Rating for KN03A-AA .....	D-4
D-4	H7878-A Power Supply Output Characteristics .....	D-5

---

## Using This Guide

This guide explains how to operate the hardware components of your DECstation 5000 Model 240 Series workstation. It discusses the following topics:

### In Part I, "Introducing Your Workstation,"

- The parts that make up the basic DECstation 5000 Model 240 Series workstation
- The function of each workstation component
- How to set up each part of your workstation
- How to adjust your workstation hardware for your comfort
- The site and voltage requirements for your workstation
- How to power up, test, and shut down your workstation
- How to read the configuration displays and interpret the power-up and system self-test results
- How to dismantle your workstation in preparation for moving

### In Part II, "External Additions to Your Workstation,"

- How to connect external storage devices to your workstation
- How to connect your workstation to the Ethernet network
- How to connect external communications options to your workstation

In Part III, "Internal Parts and Additions to Your Workstation,"

- What each internal component of the system unit does
- The internal components you can add to improve workstation performance
- How to open and close the system unit
- How to use an antistatic wrist strap
- How to install and remove internal options

In Part IV, "Managing Your Workstation,"

- How to use console and operating modes
- How to install and use a terminal as a separate system console
- How to use console commands
- How to diagnose and solve basic hardware problems

In Part V, "Appendixes,"

- Specifications for your workstation components
- Part numbers for your workstation components
- Pin assignments for your workstation cables and connectors
- Regulatory information for the UK

**Table 1. Conventions Used in This Guide**

Convention	Use
Monospace type	Anything that appears on your monitor is set in monospace type like this.
<b>Boldface type</b>	<b>Anything that you are asked to type is set in boldface type like this.</b>
Caution note	Information that protects the workstation from being damaged is set off in a caution note.
Warning note	Information that protects you from being harmed is set off in a warning note.

# Part I

---

## Introducing Your Workstation



---

## The Main Components and How to Install Them

This chapter tells you about the main parts of your workstation and how to install each of the following parts:

- System unit
- Monitor
- Keyboard
- Mouse and other pointing devices

## The System Unit

The system unit is the central component of your workstation. It contains the memory, central processing unit (CPU), power supply, and connectors by which you attach the monitor, keyboard and mouse, and all other parts of your workstation.

The system unit has a built-in small computer systems interface (SCSI) connector to which you can attach multiple external storage devices (tape, disk, and compact disc drives). It also has a built-in ThickWire Ethernet connector to connect your workstation to an Ethernet network. You can connect terminals, printers, plotters, or modems to its two synchronous/asynchronous RS232 serial communications connectors.

There are three TURBOchannel option slots on the system unit in which you can install TURBOchannel option modules. TURBOchannel option modules provide the hardware needed to connect and operate various workstation additions and options. The basic workstation comes with a graphics option module to which you attach the workstation monitor. The graphics option module can be installed in one of the TURBOchannel option slots on the system unit or in a TURBOchannel extender unit connected to the system unit.

The following sections explain and describe

- Front of the system unit
- Back of the system unit
- Installing the system unit

For information about replaceable modules inside the system unit, refer to Chapter 8.

## Front of the System Unit

The front of the system unit has a green power indicator light. The light glows steadily when the system is operating correctly.

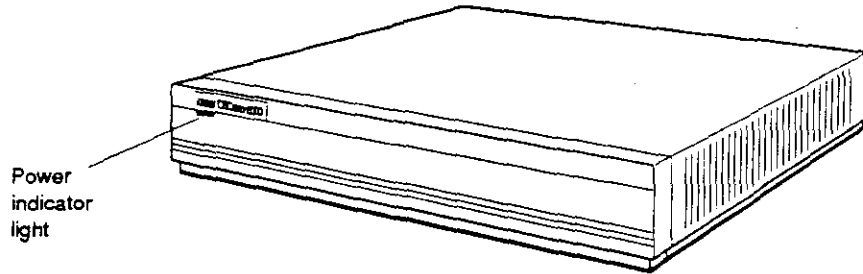

WS3PO014

Figure 1-1. Front of the system unit

## Back of the System Unit

On the back of the system unit you will find the items shown in Figure 1-2. Table 1-1, which follows, explains each item.

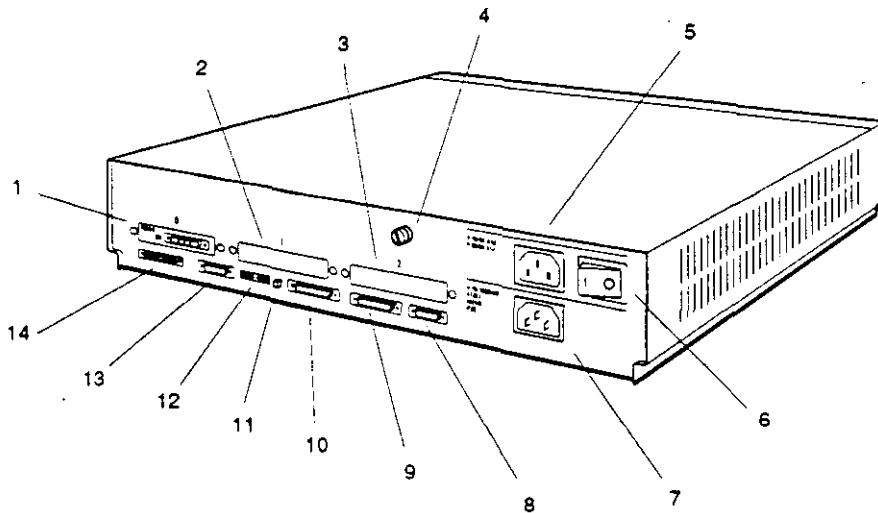

- |   |   |
|---|---|
| 1. TURBOchannel option slot 0<br>with graphics module installed | 8. Keyboard-mouse connector                     |
| 2. TURBOchannel option slot 1                                   | 9. Communications connector 2                   |
| 3. TURBOchannel option slot 2                                   | 10. Communications connector 3                  |
| 4. Cover-release screw  | 11. Halt button                                 |
| 5. Monitor-to-system-unit power connector                       | 12. Diagnostic LED display                      |
| 6. On/off switch  | 13. Base system ThickWire Ethernet<br>connector |
| 7. System unit power connector                                  | 14. Base system SCSI connector                  |

WS3PO013

Figure 1-2. Back of the system unit

**Table 1-1. Connectors, Controls, LED Display, and Lights on the System Unit**

Item	Function
TURBOchannel option slots 0, 1, and 2	The points at which optional TURBOchannel hardware can connect to the system unit.
Cover-release screw	A captive screw that allows the cover to be removed from the system unit.
Monitor-to-system-unit power connector	The point at which power can pass from the system unit to the monitor.
On/off switch	The switch that turns the system unit on and off. Pressing the 1 turns the system unit on. Pressing the 0 turns it off.
System-unit power connector	The point at which power from the power source reaches the system unit.
Keyboard-mouse connector	The point at which the keyboard-mouse cable connects the keyboard and mouse or tablet to the system unit.
Communications connectors	The points at which communications devices, such as modems and printers, connect to the system unit.
Diagnostic LED display	Eight small red lights that indicate an error code by means of the on-off pattern displayed when a system failure occurs.
Halt button	The switch that stops the worksystem software and puts the workstation in console mode.
Base system ThickWire Ethernet connector	The point at which Ethernet network cables connect to the system unit.
Base system SCSI connector	The point at which external SCSI storage devices connect to the base system.
Power indicator light	The light on the front of the system unit that indicates whether the unit is on or off.

## Icons on the System Unit

The connectors on the back of the system unit are labeled with the following icons to remind you of their functions:

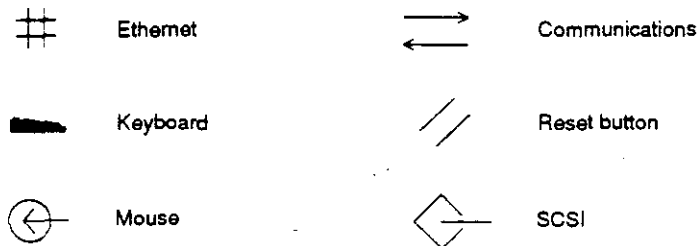

WS3PO015

Figure 1-3. Icons on the system unit

## Setting Up the System Unit

Before setting up the system unit, check the voltage requirement labels printed on the back of the system unit (or check for a yellow voltage label covering the system unit power connector).

**Caution:** *Connecting a device to a power source that does not meet the voltage requirements of that device can damage the device.*

1. Place the system unit flat on a level surface.

**Caution:** *Standing the system unit on its side blocks the cooling vents and can damage the unit by causing it to overheat.*

2. Install a ThickWire Ethernet loopback connector on the base system Ethernet connector and on each Ethernet connector you may have in a TURBOchannel option slot. Hold the loopback connector so the widest part of the metal rim on the connector is on top. Then firmly press the connector onto the system unit Ethernet connector. (See Chapter 6 for information on connecting your workstation to an Ethernet network.)

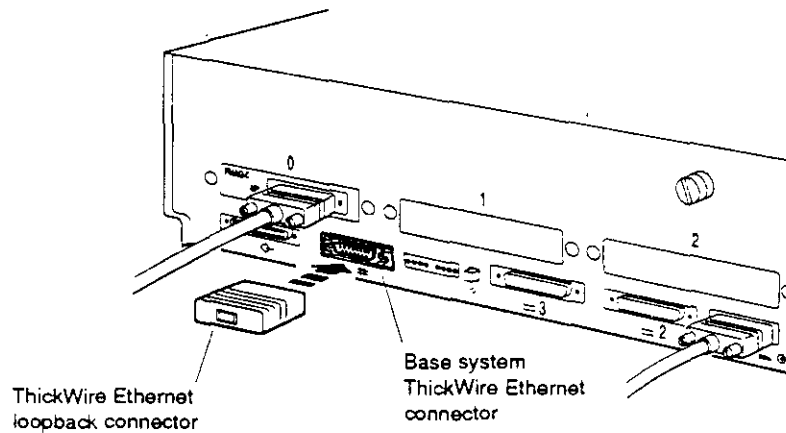

WS3PO030

Figure 1-4. Attaching a ThickWire Ethernet loopback connector

3. Connect the appropriate end of the system unit power cord to the system unit power connector.

Do not plug the power cord into a power outlet until you have installed all of the other workstation components.

*Caution: Installing workstation components while the system unit is connected to a power source may damage the components if the power is on.*

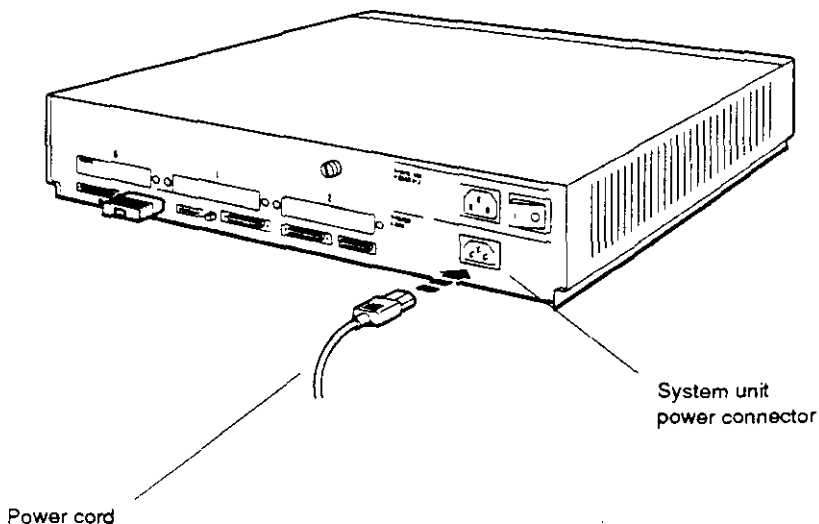

WS3PO084

**Figure 1-5. Connecting the power cord to the system unit**



## The Monitor

Your workstation comes with a color, monochrome, or gray-scale graphics monitor for use with your worksystem software and as a system console. You can also connect a terminal to your workstation for use as an alternate system console (see Chapter 10 for details).

The monitors shown in the illustrations for this guide are examples of several different monitors you can order for your workstation. The exact position of the on/off switch, connectors, and controls will vary depending on the monitor you ordered.

The video connector to which the monitor attaches can be located in any one of the TURBOchannel option slots on the system unit or in a TURBOchannel extender (TCE) unit, connected to the system unit. The examples used here assume that the video connector is in TURBOchannel option slot 0.

### Turning Your Monitor On and Off

Before connecting the monitor, make sure the monitor and system unit power switches are in the off position, and that neither unit is plugged into a power source.

*Caution: Connecting or disconnecting your monitor while power is turned on can damage the monitor.*

Figure 1-6 shows how to turn the monitor power off with three different types of switches.



Press the 0 on this type of switch.



Press and release this type of switch.



Press this type of switch so it is out.

WS3PO017

**Figure 1-6. Turning off your monitor**

You can turn your monitor on and off independently, or you can install it so that it goes on and off when you turn the main workstation power on or off (for details, see "Supplying Power to the Monitor" on page 1-18). Figure 1-7 explains how to set the monitor power switch to the on position.



Press the | on this type of switch.



Press and release this type of switch.



Press this type of switch in.

WS3PO057

**Figure 1-7. Turning on your monitor**

### **Positioning the Monitor**

Place the monitor next to or on top of the system unit if you intend to connect its power cord to the system unit (see "Supplying Power to the Monitor" on page 1-18 for other options).

***Caution:** Placing the monitor near an electromagnetic device, such as a printer or an electric pencil sharpener, or near magnetized objects, such as filing cabinets or steel beams in walls, can interfere with its performance.*

## Connecting the Monitor Video Cable

You connect one of the following monitor video cables to your monitor and to the system unit.

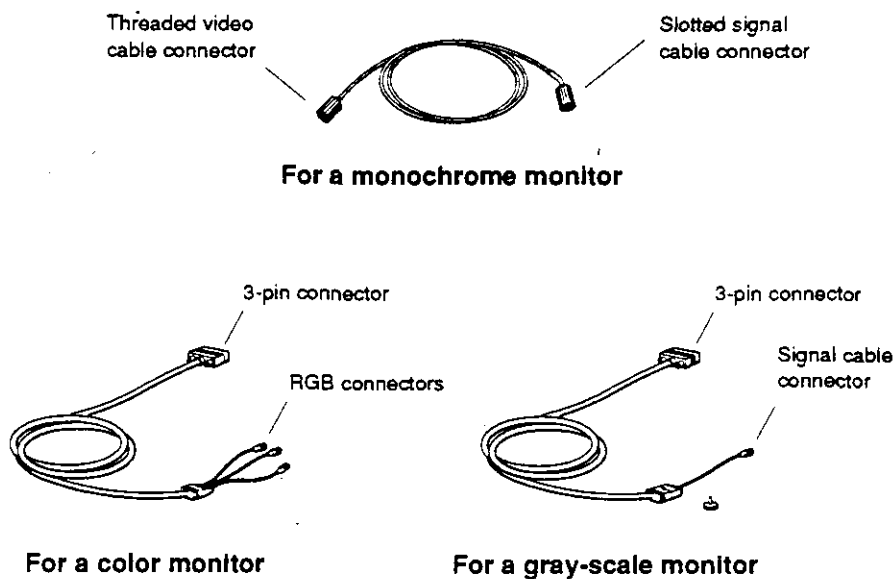

WS3PO016

Figure 1-8. Video cable assemblies

## To Connect a Color Video Cable

1. The color video cable divides into red, green, and blue (RGB) cables at one end. Match the colors of these cables with the round RGB connectors on the monitor (labeled R, G, and B for red, green, and blue). The small collars on the cable connectors have two slots that fit over corresponding pins on the monitor connectors.

If your monitor has two sets of round RGB connectors, use the ones labeled VIDEO IN. The monitor will have no display if you use the other set of connectors.

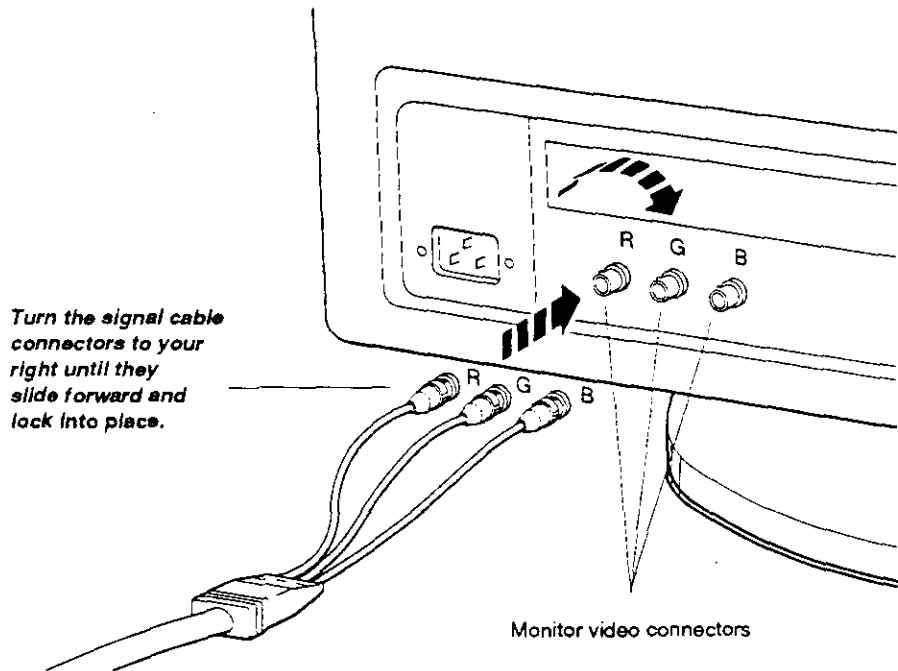

WS3PO019

Figure 1-9. Connecting a video cable assembly to a color monitor

2. Connect the 3-pin cable connector to the workstation video connector in the system unit or TCE box.

1. *Position the 3-pin cable connector so the widest part of the connector is on top.*

System unit video connector in TURBOchannel option slot 0

2. *Turn the screws to your right to hold the connector in place.*

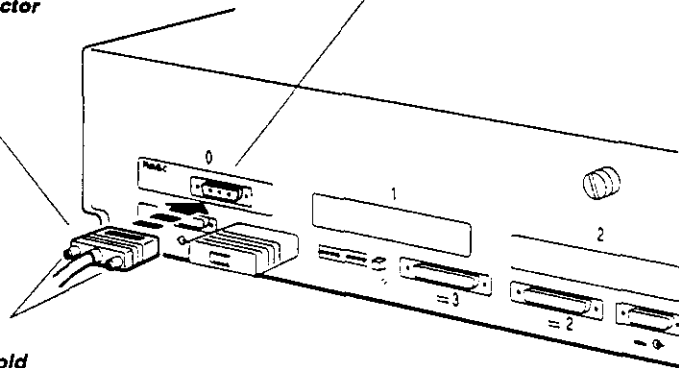

WS3PO073

Figure 1-10. Connecting a color video cable to the system unit

## To Connect a Gray-scale Video Cable

1. Attach the round cable connector to the monitor.
2. Attach the connector block to the back of the monitor.

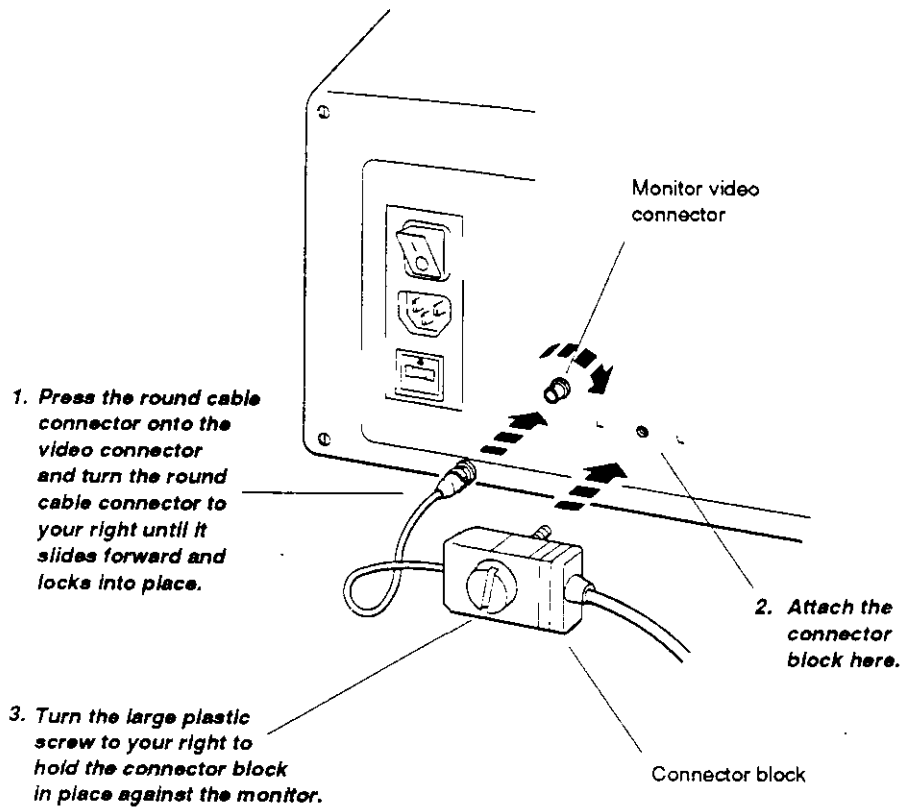

WS3PO020

Figure 1-11. Connecting a video cable assembly to a gray-scale monitor

3. Attach the 3-pin cable connector to the system unit video connector in the system unit or TCE box.

1. *Position the 3-pin cable connector so the widest part of the connector is on top.*

System unit video connector in TURBOchannel option slot 0

2. *Turn the screws to your right to hold the connector in place.*

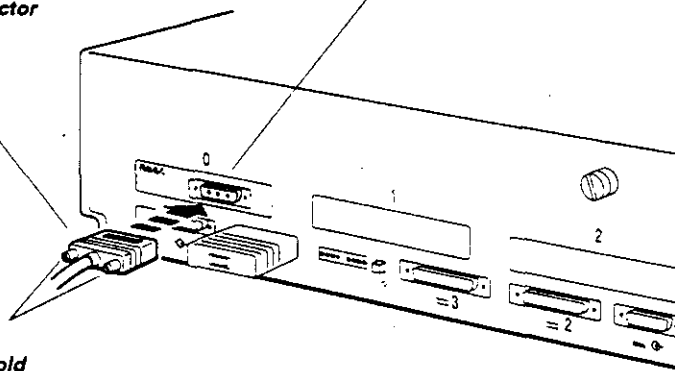

WS3PO073

Figure 1-12. Connecting a grey-scale video cable assembly to the system unit

## To Connect a Monochrome Video Cable

1. Attach the slotted cable connector to the monitor video connector.

*1. Align the slots on the cable connector with the pins on the monitor video connector.*

*2. Press the slotted cable connector onto the monitor connector and turn the slotted cable connector to your right until it slides forward and locks into place.*

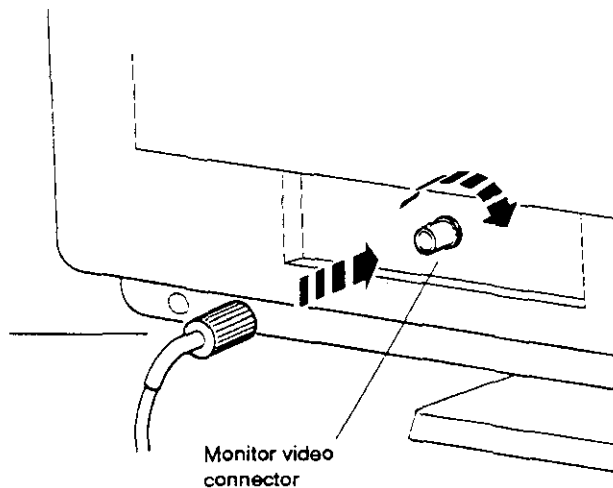

WS3PO072

**Figure 1-13. Connecting a video cable assembly to a monochrome monitor**



2. Attach the threaded cable connector to the video connector in the system unit or TCE box.

*Press the threaded cable connector onto the video connector and turn the threaded connector to your right as far as it will go.*

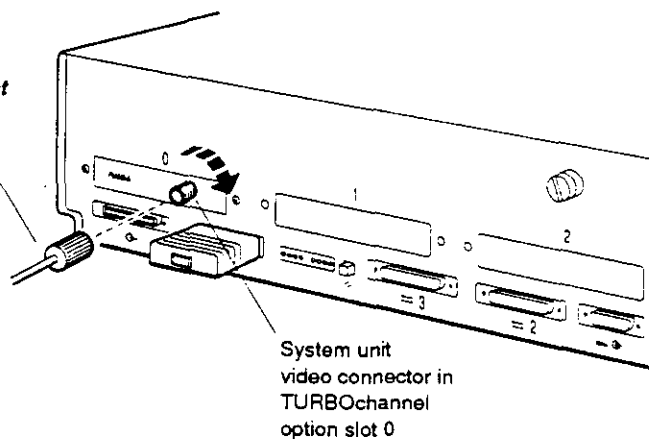

WS3PO071

Figure 1-14. Connecting a monochrome video cable assembly to the system unit

### Connecting More Than One Monitor to a Workstation

You can connect an additional monitor for each TURBOchannel graphics option module you may have installed. All graphics option modules must be the same type. Also, your workstation must be running an advanced installation of ULTRIX version 4.2 or higher. No matter how many monitors you attach to your workstation, you can use only one keyboard and mouse or other pointing device.

To connect additional monitors to your workstation, follow the instructions for connecting a single monitor. To install graphics option modules inside the system unit, follow the instructions in your TURBOchannel user documentation.

## Supplying Power to the Monitor

The monitor can get its power from one of these:

- System unit

When the monitor is connected to the power outlet on the system unit, the monitor goes on or off whenever you turn the system unit on or off, if you set and leave the monitor power switch in the on position.

- Power strip

When the monitor is connected to a power strip, you can turn it on and off by turning the power strip on or off, if you set and leave the monitor power switch in the on position.

- Separate wall outlet

When the monitor is connected to a separate wall outlet, you have to turn the monitor on and off independently of the system unit.

The length of the cable supplied with your workstation to connect the monitor to the system unit power outlet may limit the location of the monitor. If you want to install the monitor at a distance from the system unit, connect the monitor to a power strip or wall outlet with a monitor power cord, or you can order a longer monitor-to-system-unit power cable.

Before connecting any power cords or cables, check for a yellow voltage label covering the power connector on the monitor or a voltage requirement printed on the monitor near the power outlet.

**Caution:** *Connecting a device to a power source that does not meet the voltage requirements of that device can damage the device.*

**To Connect the Monitor to the System Unit Power Outlet**

1. Find the monitor-to-system-unit power cable.

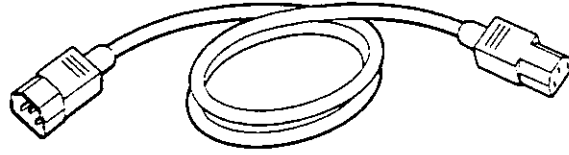

WS3PO085

**Figure 1-15. Monitor-to-system-unit power cable**

2. Plug the appropriate end of the monitor-to-system-unit power cable into the power connector on the back of the monitor.

Plug the other end into the monitor-to-system-unit power connector on the back of the system unit.

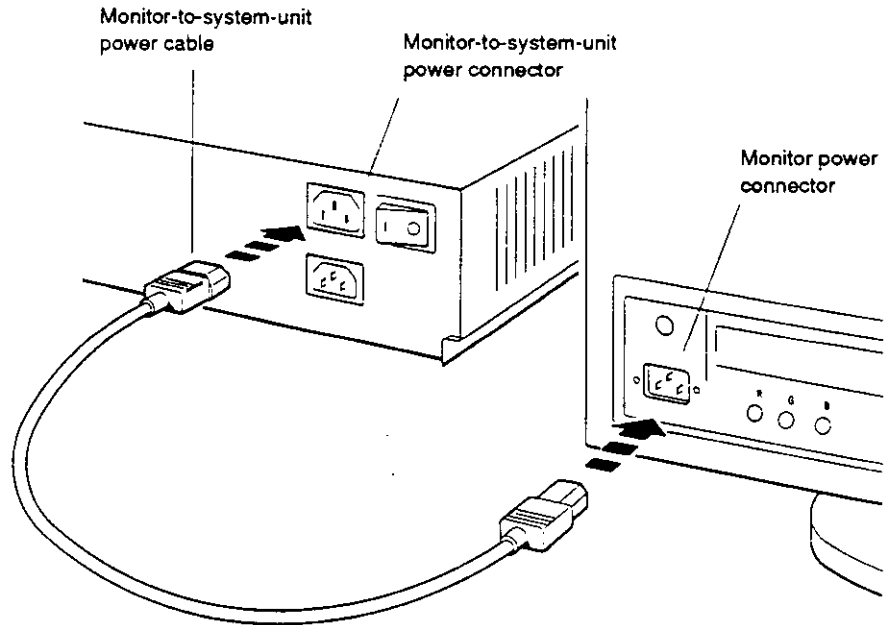

WS3PO070

**Figure 1-16. Connecting the monitor-to-system-unit power cable**

3. Check to make sure the power to the system unit is off. Then set the monitor power switch to the on position (see "Turning Your Monitor On and Off" on page 1-9).

**To Connect the Monitor to an Independent Power Outlet**

1. Find the monitor power cord (identical to the system unit power cord).

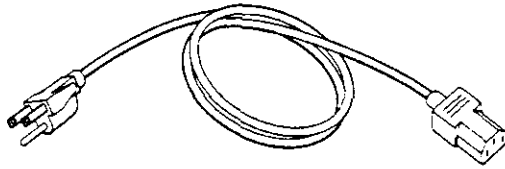

WS3PC086

**Figure 1-17. Monitor power cord**

2. Plug the appropriate end of the monitor power cord into the power connector on the back of the monitor.

Plug the other end of the power cord into a power strip or separate wall outlet.

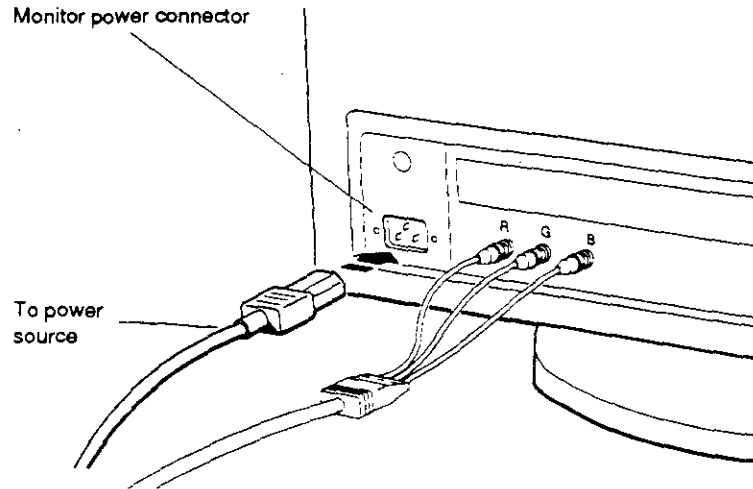

WS3PO035

Figure 1-18. Connecting a separate monitor power cord

3. If you intend to turn your monitor on and off independently, set the monitor power switch to the off position.

If you intend to control the power to your monitor by turning the power strip on and off, set the monitor power switch to the on position.

For instructions on operating the monitor power switch, see "Turning Your Monitor On and Off" on page 1-9.

## Input Devices

The following input devices can be connected to your workstation:

- Keyboard
- Mouse
- Tablet and puck or stylus
- Dial and button box

### The Keyboard

You have a choice of a full-sized or smaller version of the keyboard.

#### The LK401 Keyboard

The LK401 is a full-sized keyboard. The main part of the LK401 keyboard resembles a typewriter keyboard. In addition to the main keys, the LK401 keyboard has some special function keys, a special editing keypad, and a numeric/application keypad. The manuals for your software explain how to use the special keys.

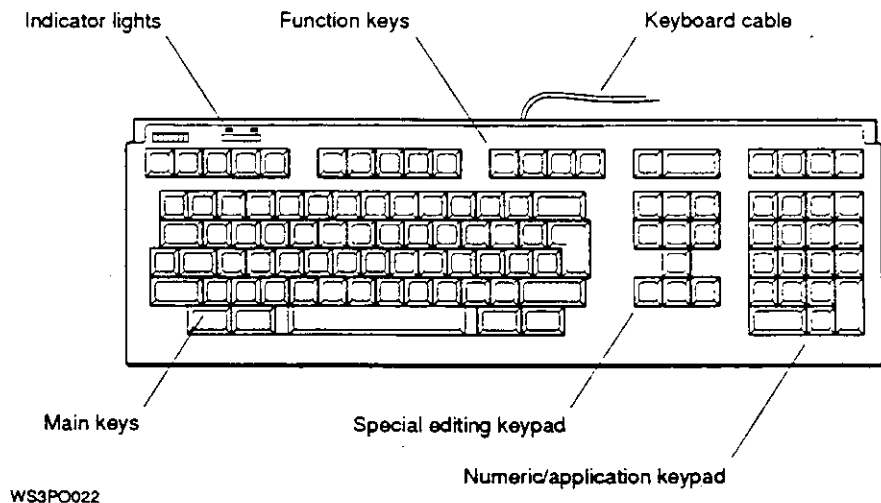
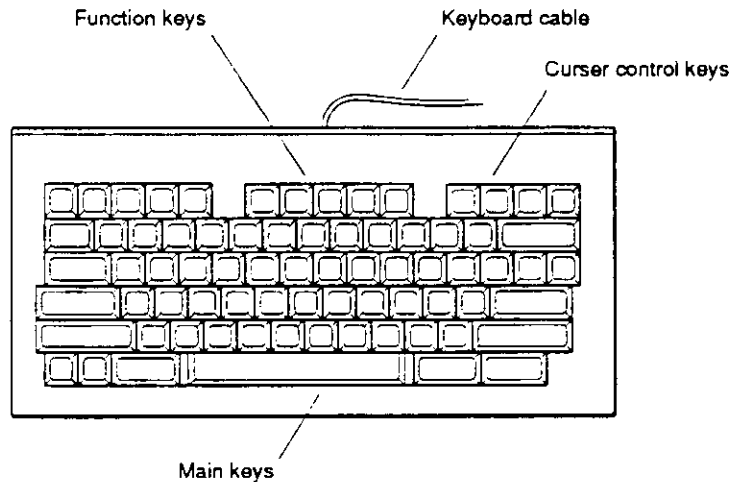

Figure 1-19. LK401 keyboard

### The LK421 keyboard

The LK421 is a smaller keyboard that more closely resembles a typewriter keyboard. In addition to the main typewriter-style keys, it has cursor control keys and special function keys F1 to F12. It has no separate editing keypad or numeric/application keypad.



WS3PO068

Figure 1-20. LK421 keyboard



### Connect the Keyboard to the System Unit

You connect the keyboard to the system unit using a keyboard-mouse cable assembly.

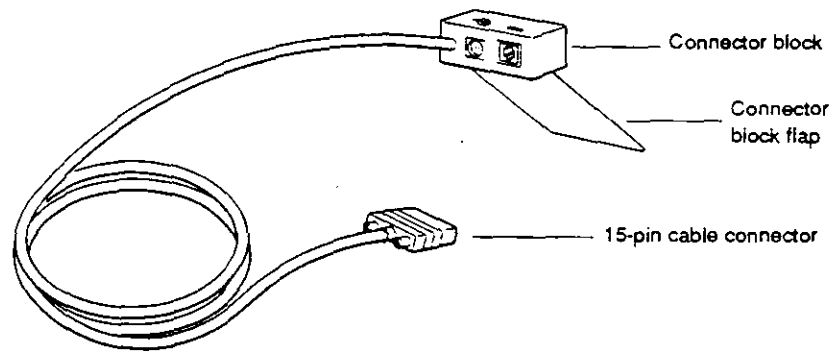

WS3PO082

Figure 1-21. Keyboard-mouse cable assembly

1. Plug the 15-pin connector on the keyboard-mouse cable assembly into the keyboard-mouse connector on the system unit.

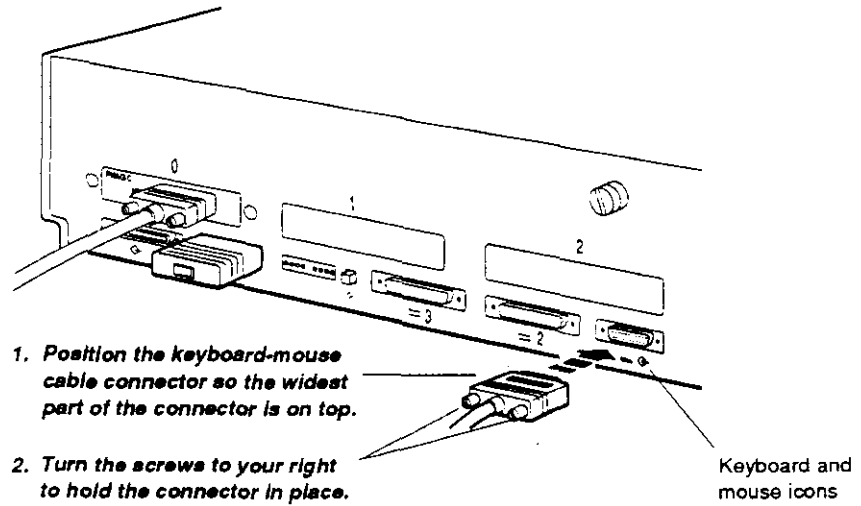

WS3PO081

Figure 1-22. Connecting the keyboard-mouse cable assembly to the system unit

2. Insert the keyboard cable connector into the connector block of the keyboard-mouse cable assembly.

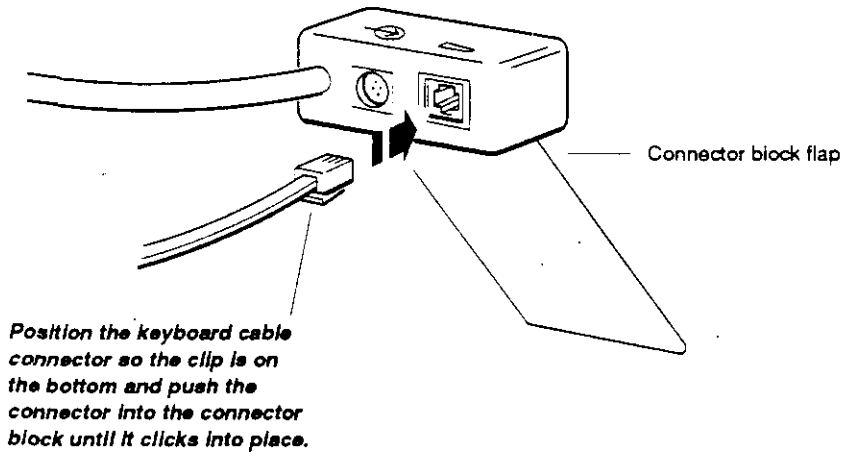

WS3PO083

Figure 1-23. Connecting the keyboard cable to the connector block

3. Lift the back of the monitor, slide the flap on the connector block under the base of the monitor, and lower the base onto the flap. Be sure the entire flap is under the base.

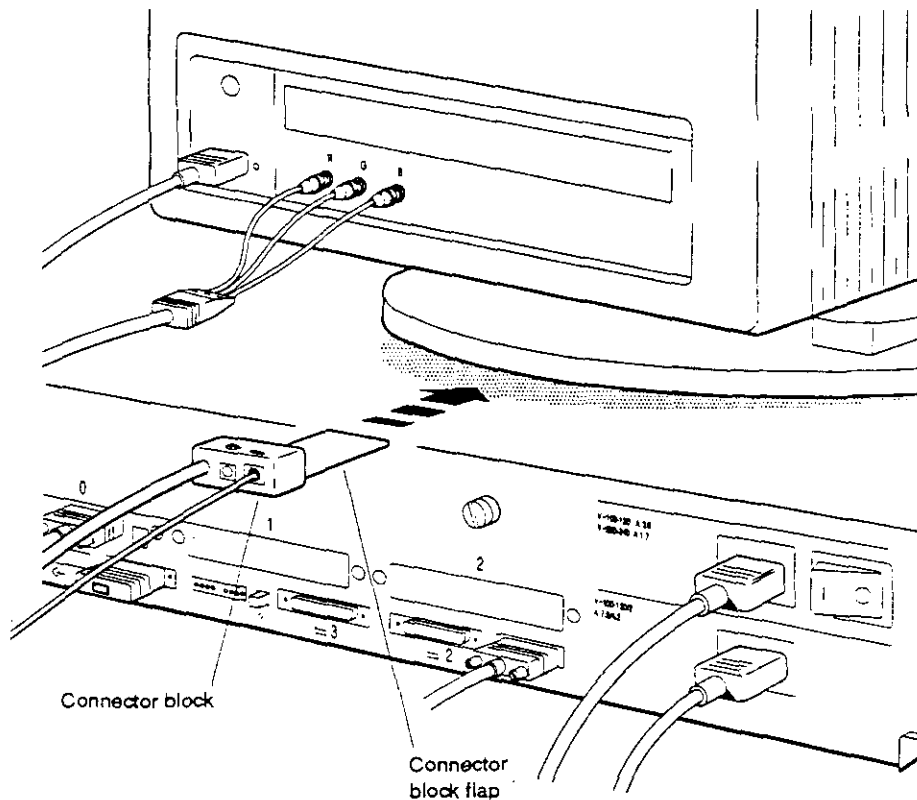

WS3PO026

Figure 1-24. Positioning the connector block

### To Adjust the Keyboard Feet

You can use the keyboard in either of two positions, depending on which you find most comfortable: you can lay the keyboard flat on your work surface, or you can slant it towards you at a slight angle. To position the keyboard, you raise or lower the hinged feet on the bottom of the keyboard.

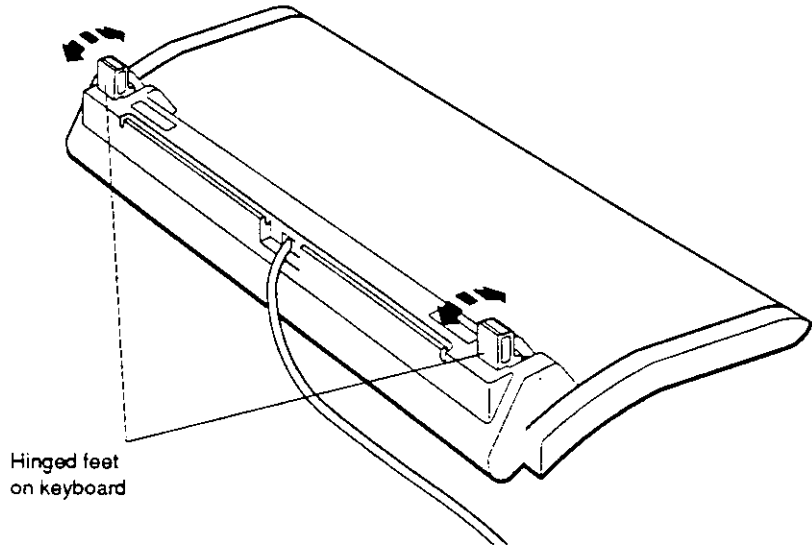

WS3PO023

Figure 1-25. Raising and lowering the hinged feet on the keyboard

## Pointing Devices

You use a pointing device to move the pointer and cursor on the monitor screen.

### The Mouse and Tablet

The main pointing device for your workstation is a mouse. As an alternative to a mouse, you can use a tablet and stylus as a pointing device. You cannot use both a mouse and a tablet and stylus at the same time.

Your software manuals explain how to use the devices.

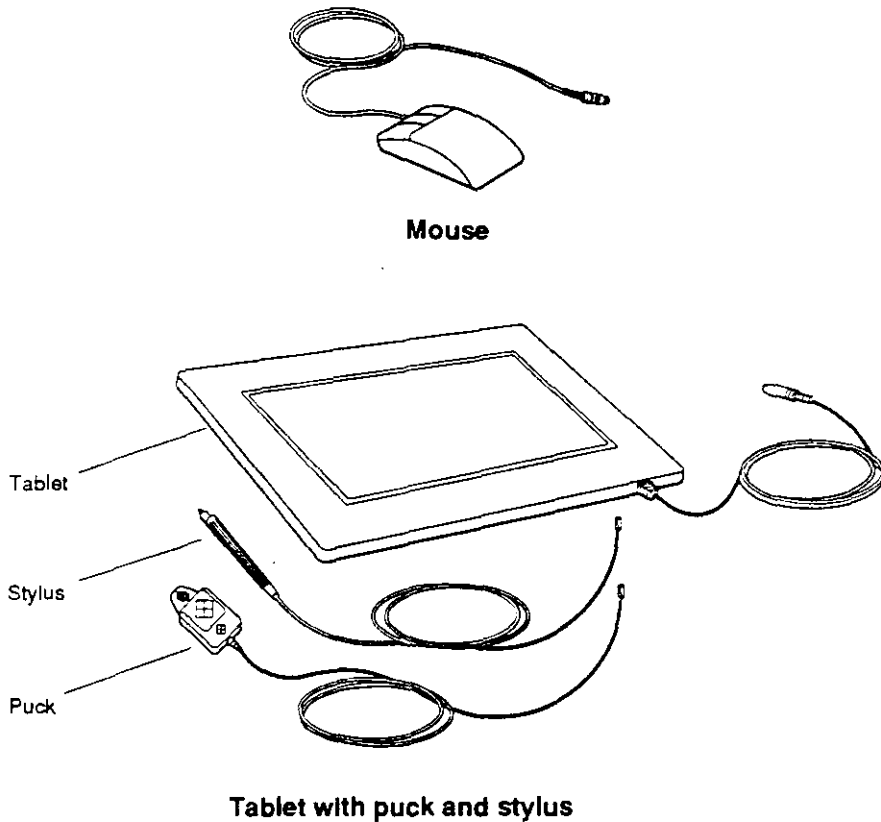

WS3PO002

Figure 1-26. Pointing devices

You connect the mouse (or tablet and stylus) to the connector block on the keyboard-mouse assembly that attaches to the system unit.

1. Position the mouse or tablet cable connector so the icon on it is below the mouse icon on the connector block.
2. Push the cable connector as far as it will go into the connector block.

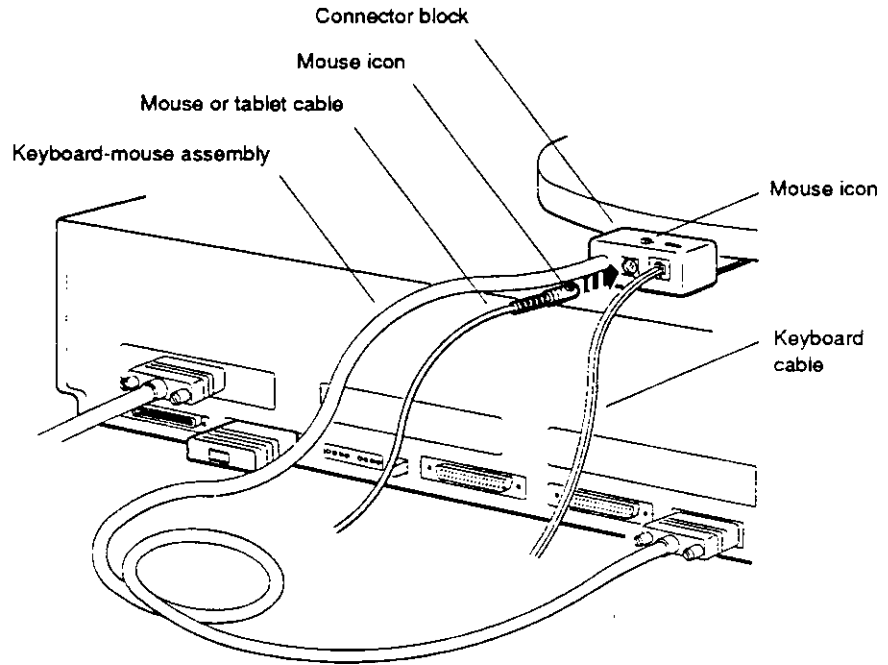

WS3PO028

**Figure 1-27. Connecting the mouse or tablet**

## Dial and Button Boxes

If you are using computer-aided design (CAD) applications with your workstation, you may want to connect a dial box or a button box in addition to the mouse or tablet. Dial and button boxes allows you to easily rearrange the contents of a graphic screen display. You connect a dial or button box to one of the communications connectors on the system unit. For installation information, refer to the documentation supplied with the device.

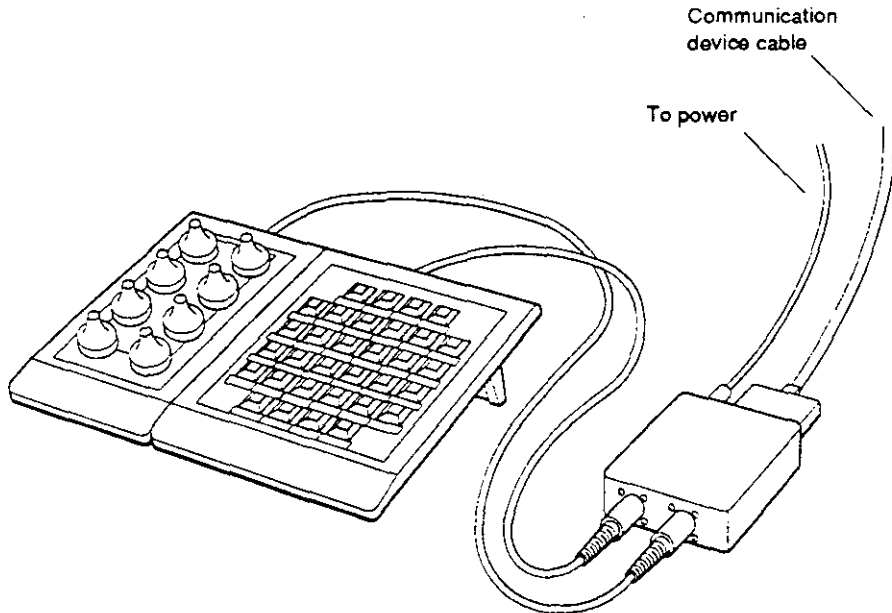

WS3PO024

**Figure 1-28. Dial and button boxes**



## Adjusting and Positioning Your Workstation for Comfort

You can make several adjustments to your workstation monitor and keyboard for your comfort. You can

- Position the monitor on top of or beside the system unit.
- Anchor the keyboard-mouse cable assembly connector block under the monitor base, or wherever is convenient.
- Tilt and swivel the monitor on its stand.
- Adjust the monitor brightness and contrast controls.
- Slant the keyboard toward you or lay it flat by raising or lowering the hinged keyboard feet.

For more specific instructions, turn to the section of this manual that tells you about that device or refer to the documentation that came with the device.

# 2

---

## The Right Environment

This chapter discusses

- The environment your workstation needs to function efficiently
- The voltage requirements for your workstation

## Site Requirements

To operate at its best, your workstation must be set up in a place that meets certain requirements.

*Caution: Failure to meet these requirements can damage equipment.*

### Temperature and Humidity

- Keep the temperature around the workstation between 50°F (10°C) and 104°F (40°C).
  - Set up your workstation away from heaters, photocopiers, and other sources of heat.
  - Protect your workstation from direct sunlight.
- Allow air to flow freely around your workstation to keep heat from building up and damaging your equipment.
  - Leave 4 inches (10 centimeters) of space between system unit vents and other objects.
  - Leave 3 inches (8 centimeters) of space between monitor vents and other objects.
- Keep relative humidity within the range of 10 to 90 percent.

### Cleanliness

- Keep your work area as dust-free as possible.

### Interference

- Set up your workstation at least 30 inches (76.2 centimeters) away from other terminals or monitors and from other sources of electrical interference, such as printers or electric pencil sharpeners.
- Limit exposure to static electricity and magnetized objects by setting up your workstation away from busy corridors and other high-traffic areas and away from filing cabinets and steel beams in walls.

## Power

- Reserve an entire circuit for your workstation's power source. The fuse for the circuit must be at least 15 amperes.
- Be sure your electrical circuit is properly grounded. The use of a surge-protected power strip is recommended for connecting the power cord to your workstation.
- Be sure the voltage for workstation devices matches that of your power source.

## Supplies

- Store supplies, such as tape cartridges, within the same temperature and humidity limits as those for your workstation.

## Workstation Voltage Requirements

The voltage for many devices, including most monitors, must match that of your power source. Your power source is either 110/120 or 220/240 volts. Where necessary, a yellow voltage label that covers the power connector on your device tells you the voltage requirements for that device.

*Caution: Connecting a device to a power source that does not meet the voltage requirements of that device can damage the device.*

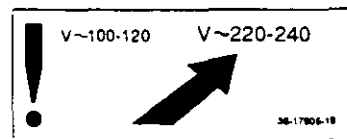
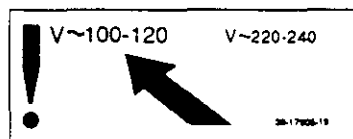

WSE21021

Figure 2-1. Voltage labels

---

## Starting and Testing

This chapter explains

- How to turn on your workstation
- How the power-up and system self-tests operate
- How to set your keyboard language
- How to check your workstation configuration
- How to stop your worksystem software
- How to turn off your workstation

## Turning On Your Workstation

Before turning on your workstation for the first time,

- Make sure the system unit power cord is plugged into a wall outlet or power strip.
- Make sure the monitor and any external devices are plugged into a power source.
- If any components of your workstation are plugged into a power strip, make sure the power strip is plugged into a power outlet.
- If you intend to control power to your workstation by turning the power strip on and off, make sure all power switches on the workstation components are set to the on position.

If all workstation components are plugged into a power strip, turn on the power strip to turn on your workstation. If some of your workstation components are plugged into different outlets, turn on your workstation in the order described here:

1. Turn on any external devices. Most devices have rocker switches. Some have push switches.
2. If necessary, turn on the monitor.
  - If the monitor gets its power through the system unit, and if you have set the monitor power switch to the on position, it will go on when you turn on the system unit.
  - If the monitor is plugged into a wall outlet, or if the monitor power switch is in the off position, turn it on now (for instructions, refer to the documentation that came with the monitor or turn to "Turning Your Monitor On and Off" on page 1-9).

When the monitor turns on, a green indicator light glows on the front of the monitor. The monitor must run for 10 to 15 seconds before it is warmed up enough for the display to be visible.

3. Turn on the system unit by pressing the 1 on the on/off switch on the back of the system unit.

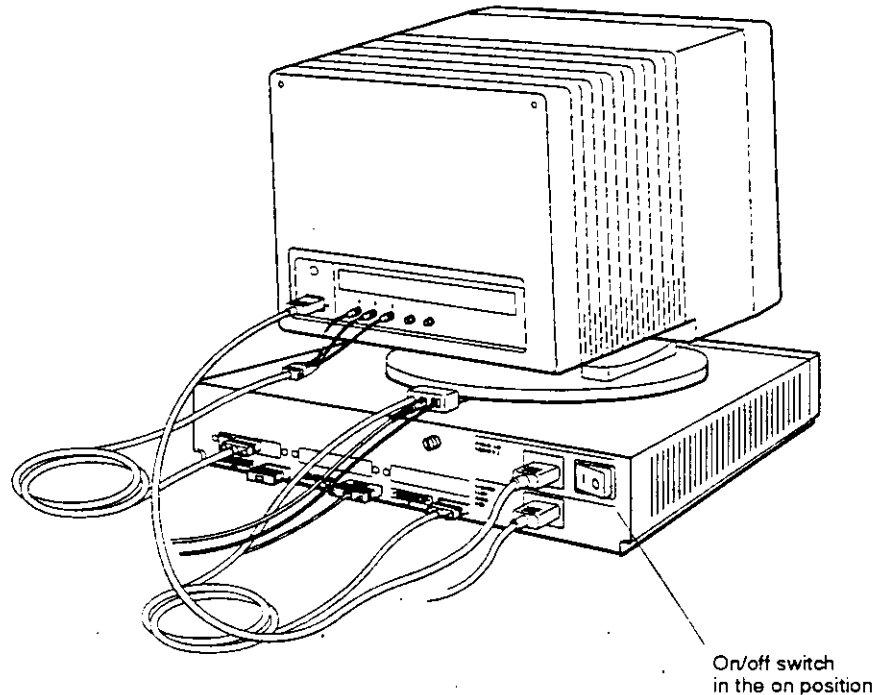

WS3PO058

**Figure 3-1. Turning on the system unit**

4. When you turn on the system unit, the following things happen:
  - The green power indicator light glows on the front of the system unit.
  - The system unit runs the automatic power-up self-test, which takes from 1 to 5 minutes. It displays the names of each subtest that it runs at the bottom of the screen. Some tests display asterisks (\*) and other symbols, and some tests cause the screen to flicker.

If you have multiple monitors, the monitor connected to the graphics module in the lowest numbered option slot displays all system test information. At the end of the power-up self-test, messages explaining any errors that occurred during any of the subtests scroll across the screen. (You can redisplay these messages later.)

For more information on the power-up self-test, see "Testing Your Workstation" on page 3-6.

5. If you are starting your workstation for the first time, you will be prompted to select a keyboard language (for details, see "Setting the Keyboard Language" on page 3-5).
6. The screen displays the console prompt (>>) or the restricted console prompt (R>) when the system is ready to accept user commands.

- Users can execute all console commands at the console prompt (>>).
- The restricted console prompt (R>) indicates that someone has set up a password requirement to restrict access to the system. At the restricted console prompt, you can use only the boot and passwd console commands until you enter the correct password.

To enter your password, type **passwd** and press Return. Then enter the console password at the **pwd** prompt and press Return again. If you do not know the password, contact your system manager or a Digital service representative.

If anything other than the console prompt (>>), or restricted prompt (R>) appears, turn to Chapter 11 for troubleshooting instructions.

7. At the console prompt, type **erl** and press Return to display a complete list of any error messages that scrolled across the screen during the self-test.

If you see any error messages, or if you see a message that begins with **?TFL:**, turn to Chapter 11 for troubleshooting instructions. After correcting the error, turn the system unit off and then turn it back on again.



If your system unit fails to turn on, turn it off and check to be sure that

- Power cords are connected properly, and the power strip, if there is one, is plugged in and turned on.
- There is power at all power outlets.
- All power switches are set to the on position.

If the system unit still fails to work, turn to Chapter 11 for troubleshooting instructions.

## Setting the Keyboard Language

If you are installing the workstation for the first time, the system console displays the following language menu:

- |                            |                              |
|----------------------------|------------------------------|
| 1) Dansk                   | 9) Français (Suisse Romande) |
| 2) Deutsch                 | 10) Italiano                 |
| 3) Deutsch (Schweiz)       | 11) Nederlands               |
| 4) English                 | 12) Norsk                    |
| 5) English (British/Irish) | 13) Português                |
| 6) Español                 | 14) Suomi                    |
| 7) Français                | 15) Svenska                  |
| 8) Français (Canadien)     | 16) Vlaams                   |

(1..16): \_

Type the number displayed to the left of the language you want to use. Then press Return.

The console prompt (>>) appears when the language is set.

If you need to change the workstation language, type **setenv console 0** at the console prompt and press Return. The language menu will be redisplayed. Select a language and press Return. Then type **boot** and press Return to restart the workstation.

## Testing Your Workstation

Your workstation automatically runs a power-up self-test every time you turn on the power to the system unit. Self-tests are programs that check your workstation hardware to be sure it is functioning properly.

Self-tests have numerous subtests that examine specific workstation components. When a subtest discovers a problem, it displays a coded message, called an error message, on the screen. When all the tests are done, the workstation displays the console prompt (>>).

### To Specify the Quick or Full Self-Test

You can issue one of the following console commands at the system console prompt (>>) to change the number of self-tests the workstation runs during power-up:

- To set up your system to run a quick self-test (the default setting), enter the command **setenv testaction q**.
- To set up your system to run a more thorough set of self-tests, enter the command **setenv testaction t**.

Chapter 10 explains in more detail how to use these console commands.

You can run the full set of self-tests, collectively called the system self-test, at any time. However, you must shut down your ULTRIX worksystem software first.

## How to Run the Full Self-Test at Any Time

1. If your workstation is running the ULTRIX worksystem software, type **shutdown -h now** at the ULTRIX prompt and press Return to halt the software.
2. At the console prompt (>>), type **test** and press Return.
  - As the system performs the subtests that make up the self-test, it briefly displays the name of each subtest on the screen. The tests can take 15 minutes or more to run.

At the end of the self-test, messages explaining any errors that occurred during any of the subtests scroll across the screen. Then the console displays the console prompt (>>).
  - To redisplay the error messages, type **erl** at the console prompt (>>) and press Return.

### If a Self-Test Fails

At the end of the system self-test, error messages that have been generated scroll across the screen. Use the error log command (**erl**) to redisplay these messages and to look for others.

If you see any error messages, or if you see a message that begins with **?TFL:**, turn to Chapter 11 for an explanation of the message and troubleshooting instructions.

## Checking the Configuration Display

The configuration test tells you which option modules are in your system unit. It identifies each module in your system unit by slot number and a special option module code.

Use the **cnfg** command to check the workstation configuration (see Chapter 10). Check to be sure that all the modules ordered for your workstation are listed in the display that appears on your screen. The modules you ordered are listed on the packing list for your shipment.

## Stopping the Workstation Without Turning It Off

You can shut down the ULTRIX worksystem software by typing **shutdown -h now** at the ULTRIX prompt and pressing Return.

If you are unable to return to console mode using this shutdown command, you can stop your workstation and all worksystem software by pressing the halt button on the back of the system unit. The workstation and software stop whatever they were doing, and the monitor displays the console prompt (>>). Save all open work files, if you can, before pressing the halt button.

*Caution: Pressing the halt button while you are running any worksystem software may cause the loss or corruption of data.*

You can change the specific result of pressing the halt button by issuing a console command to change the setting of the haltaction environment variable. Chapter 10 explains how to change this variable.

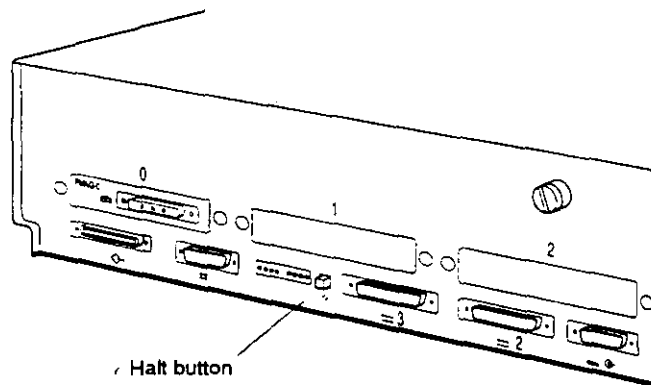

WS3PO059

Figure 3-2. Halt button and system unit on/off switch

## Turning Off the Workstation

1. If your worksystem software has been installed, follow the instructions that came with that software to shut down the software.
2. Turn off the power.
  - If your workstation and all the devices connected to it take power from a power strip, turn off the power strip.
  - If your workstation is not on a power strip,
    - Turn off any communications device by following the instructions that came with the device.
    - Turn off each expansion box.
    - If the monitor receives its power from a separate wall outlet, turn off the monitor.  
  
If the monitor receives its power from the system unit, leave it on.
    - Turn off the system unit.

# 4

---

## Taking Your Workstation Apart

This chapter tells you how to disassemble your workstation and pack it for moving.

## Dismantling Your Workstation

1. If the worksystem software is running, shut it down, following the instructions that came with the software.
2. Turn off the power to your workstation, following the procedure described in the section, "Turning Off the Workstation" on page 3-9 of this guide.
3. Wait for the system to power down. Then unplug all power cords from their power sources.
4. Disconnect all external devices, including the monitor, from the system unit. If two or more devices are chained together, disconnect them from each other.
5. Disconnect the keyboard-mouse connector block from the system unit.
6. Disconnect the keyboard and the mouse or tablet from the keyboard-mouse connector block.
7. If you are connected to an Ethernet network, disconnect the Ethernet cable from the system unit.

## Packing Your Equipment

Pack each piece of equipment in the carton it came in. Use the padding that came in the carton to hold the equipment securely in place.

Be sure to include the following in each carton:

- Any cables, power cords, adapters, and terminators that came with that device
- Any documentation that came with the device

## Reinstalling Your Workstation

To reinstall your workstation, follow the instructions in the *DECstation 5000 Model 240 Hardware Installation Guide*.

# Part II

---

## External Additions to Your Workstation



---

## External Storage Devices

This chapter explains

- What types of storage devices you can connect to your workstation
- What general rules apply to connecting storage devices to your workstation
- How to install external storage devices
- How to determine if the cable length for a group of storage devices is within the allowable limit
- How to check and set the SCSI ID of a storage device
- How to test storage devices after they are installed

## Storage Devices You Can Add to Your Workstation

External storage devices for the DECstation 5000 Model 240 workstation are small computer systems interface (SCSI) drives (such as tape, disk, and compact disc drives) that are contained in external boxes you connect to the system unit. A SCSI drive can be self-contained in its own box or can be installed in a multiple-drive expansion box such as a BA42 expansion box or a TCE. You can connect the external devices to the built-in SCSI connector on the system unit or to any SCSI connector you may have in a TURBOchannel option slot.

You can connect any of the following storage devices to your workstation:

- Any drive installed in a BA42 expansion box (for a list of specific drives, see the *BA42 Installation Guide*)
- Any drive installed in a TURBOchannel extender (TCE) unit (for a list of specific drives, see the *TURBOchannel Extender Operator's Guide*)
- Any self-contained tape, disk, or compact disc drive that conforms to SCSI specifications. Some examples are:
  - TK50Z tape drive
  - TLZ04 digital audio tape drive
  - RRD42 optical compact disc drive

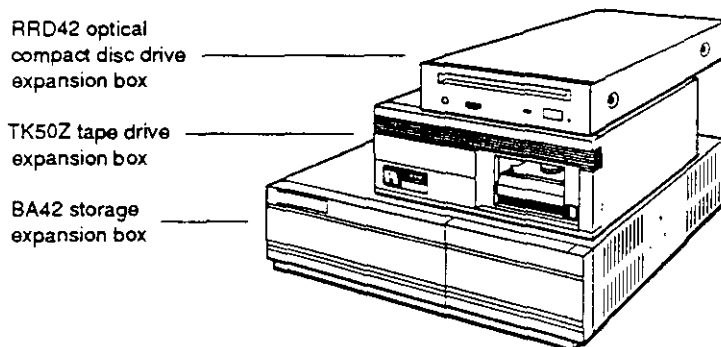

WS3PO005

Figure 5-1. Some typical expansion boxes

## Rules for Connecting Storage Devices

External storage devices must be connected to your workstation according to the following rules for the system to work properly:

- You can attach up to seven SCSI drives (either self-contained or installed in multiple-drive expansion boxes) to each SCSI connector.
  - A self-contained drive is one drive in its own box
  - A BA42 expansion box can hold one or two drives
  - A TCE can hold up to three drives
- External storage devices that use the same SCSI connector must be linked together by SCSI cables, forming a single chain of devices. Each expansion box or self-contained storage device has two SCSI connectors:
  - One connects the device or box to the base system or to the previous device or box in the chain.
  - The other connects the device or box to the next device or box in the chain.
- You must connect a SCSI terminator to the unused SCSI connector on the last device or box in a chain.
- Each drive in a chain of devices connected to one SCSI connector must have a unique SCSI ID number (see "Checking and Setting SCSI ID Numbers" on page 5-15, for information about determining and setting SCSI ID numbers.
- You can connect up to three expansion boxes to each SCSI connector.

## Installing External Storage Devices

1. Determine what external storage devices you have:
  - BA42 expansion box
  - TCE, if it has internal drives
  - Self-contained tape, disk, or compact disc drive
2. Check to make sure the number of SCSI drives and storage expansion boxes to be connected are within the allowable limits. You can connect up to seven SCSI drives, contained in up to three expansion boxes, to the base system SCSI connector.
3. Make sure each SCSI drive has a unique SCSI ID number within the group of devices you are connecting. If two or more of the drives to be connected to a SCSI connector have the same SCSI ID number, you must change the duplicate SCSI IDs (see "Checking and Setting SCSI ID Numbers" on page 5-15).
4. Position the storage expansion boxes next to or on top of the system unit. If one of the boxes is a TCE, place it directly on top of the system unit, as one of its interconnecting cables is very short. You may stack the boxes one on top of the other.
5. Set the power switches on the storage expansion boxes to the off position.



Press the 0 on  
this type of switch.

WS3PO101

Figure 5-2. Power switch in the off position

6. If the *only* device you are connecting is a TURBOchannel extender (TCE), skip the rest of this procedure, mark your place in this guide, and refer to the *TURBOchannel Extender Operator's Guide* for instructions on installing the TCE.

Otherwise, continue with these instructions.

7. Find the system-unit-to-expansion-box cable that came with your workstation.

To a SCSI connector  
on the system unit

To a SCSI connector  
on the expansion box

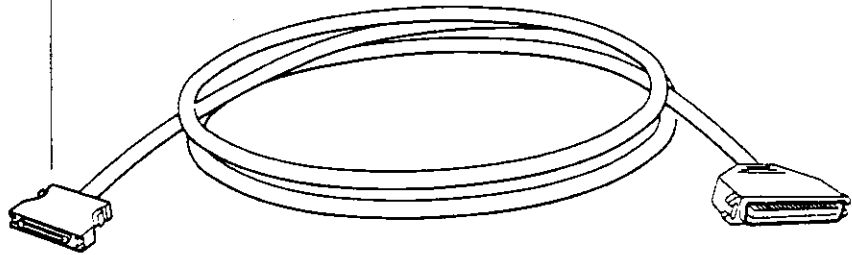

WS3PO102

**Figure 5-3. System-unit-to-expansion-box cable**

8. Attach the smaller connector on the system-unit-to-expansion-box cable to the SCSI connector on the system unit.

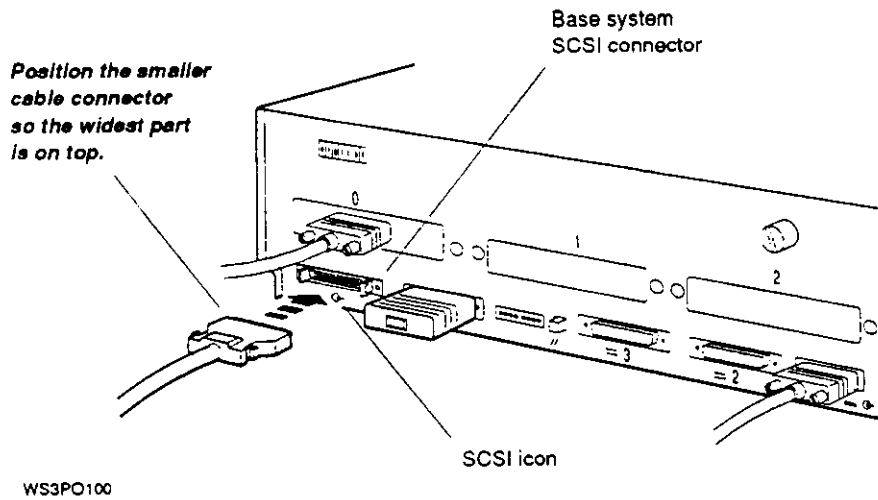

Figure 5-4. Connecting the system-unit-to-expansion-box cable to the system unit

9. Attach the larger connector on the system-unit-to-expansion-box cable to one of the SCSI connectors on an expansion box.

Do not connect this cable to a TCE, if you have one. Skip the TCE and connect the system-unit-to-expansion-box cable to the next box. (The TCE requires a different type of cable and must be connected last.)

1. Gently press the two wire brackets on the SCSI connector away from the connector.

2. Hold the cable connector so the widest part is on the top and push the cable connector into the SCSI connector as far as it will go.

3. Press the two wire brackets firmly against the sides of the cable connector until they lock into the grooves on the connector.

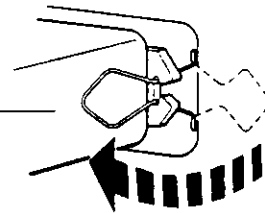
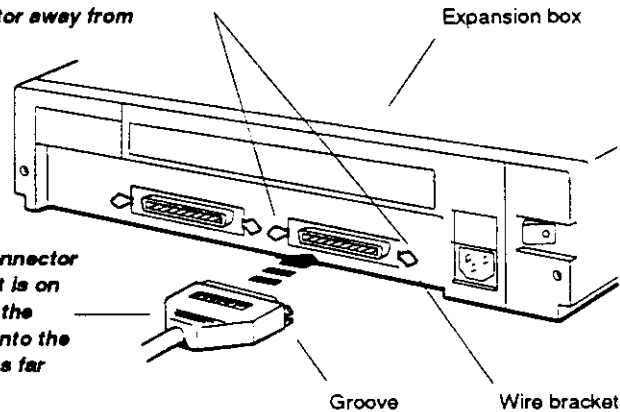

WS3PO099

Figure 5-5. Connecting the system-unit-to-expansion-box cable to expansion box

10. Connect additional non-TCE expansion boxes to the first box, using box-to-box SCSI cables.

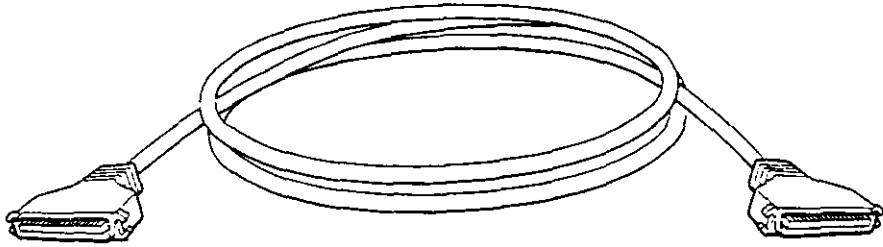

WS3PC103

**Figure 5-6. SCSI box-to-box cable**



Attach one end of a SCSI box-to-box cable to the unused SCSI connector on the previously-installed box. Connect the other end of the cable to a SCSI connector on the next expansion box.

1. Gently press the two wire brackets on the SCSI connector away from the connector.

2. Hold the connector so the widest part of the connector is on top and push it into the SCSI connector on the expansion box.

3. Press the two wire brackets firmly against the side of the cable connector until they lock into the grooves on the sides of the connector.

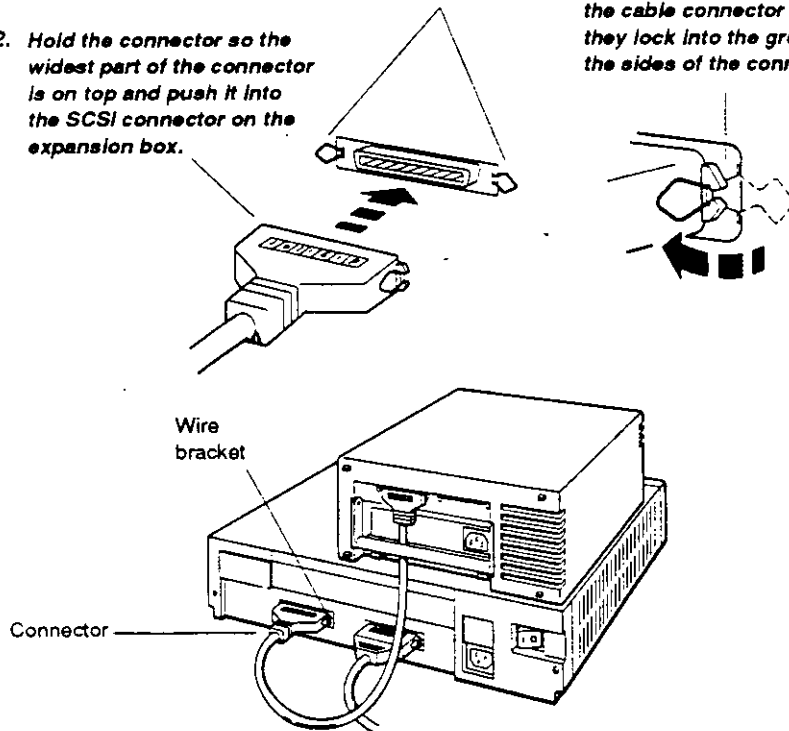

WS3PC098

Figure 5-7. Connecting an additional non-TCE expansion box to the first box

11. If one of the storage devices is a TCE with internal drives, connect the TCE to the previous expansion box or self-contained drive.
  - a. Find the TCE-to-expansion box cable that came with the TCE (identical to the system-unit-to-expansion-box cable).

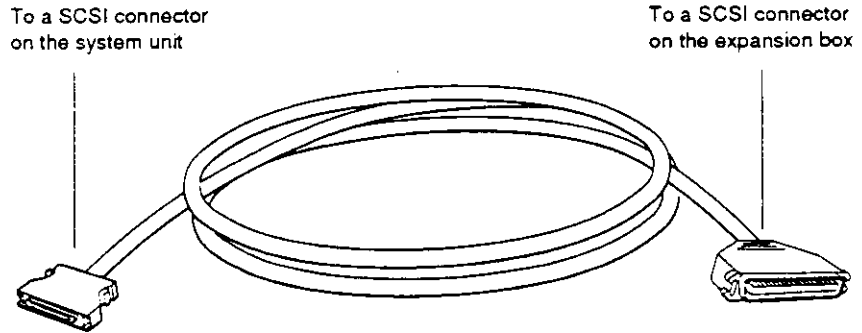

WS3PO104

Figure 5-8. TCE-to-expansion-box cable

- b. Connect the small end of the TCE-to-expansion box cable to the SCSI connector on the TCE and connect the large end to the unused SCSI connector on the previous expansion box. (The TCE must be the last box in the chain of storage devices.)

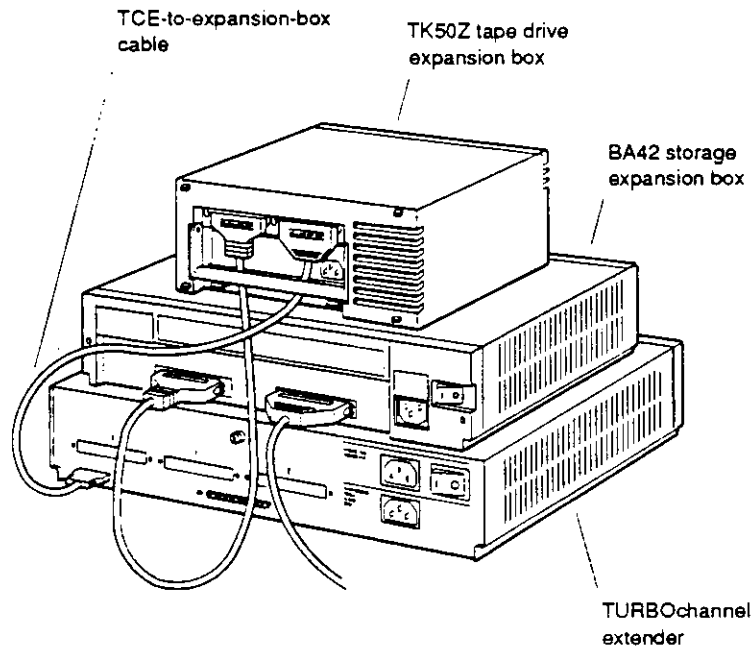

WS2PO092

**Figure 5-9. Connecting the TCE to the expansion box**

- Put a SCSI drive terminator on the unused SCSI connector on the last box you connected. If the last device you connected was a TCE, skip this step, as the TCE has its own internal SCSI terminator.

*Hold the terminator so the widest part of its connector is on top and push the terminator onto the unused SCSI connector.*

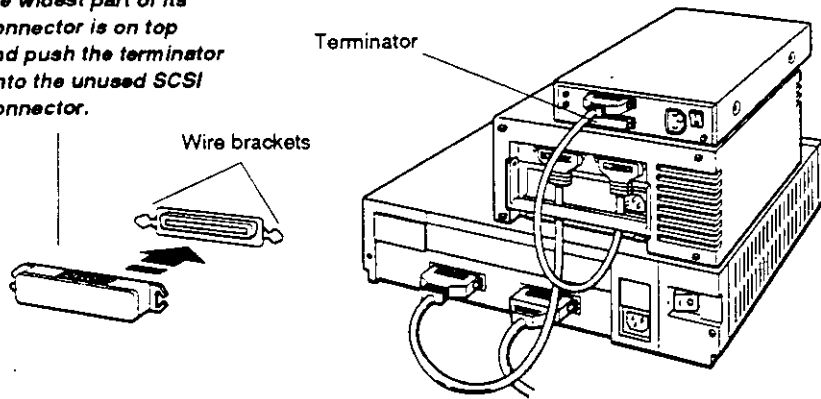

WS3PO097

**Figure 5-10. Connecting a SCSI drive terminator**

13. For each expansion box, connect one end of the power cord that came with the device to the expansion box and connect the other end to a power outlet.

**Caution:** Check the voltage requirements for the device. Connecting a device to a power source that does not meet the voltage requirements of that device can damage the device.

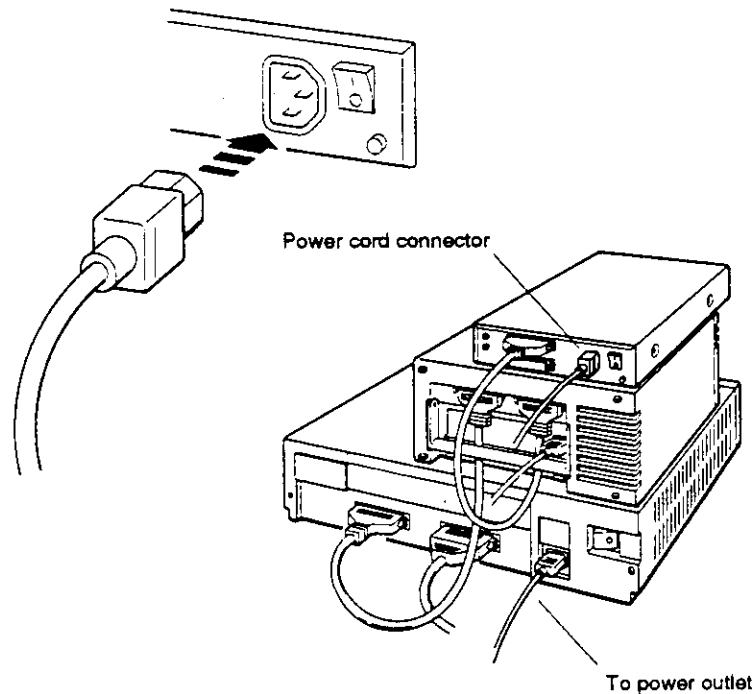

WS3PO096

**Figure 5-11. Connecting the power cord**

14. If you have additional SCSI connectors in the TURBOchannel option slots, repeat this procedure to connect any additional storage devices to these SCSI connectors.

Try to distribute the drives as evenly as possible among the SCSI connectors on the base system unit and in the TURBOchannel option slots.

## Checking the Total SCSI Cable Length

If the total length of internal and external cable used in a chain of storage devices exceeds 236 inches, the drives may not operate correctly and transmitted data may be lost. To make sure that the drives in a chain operate properly, put no more than three expansion boxes in one chain.

If you need to put more than three expansion boxes in a chain, make sure the total length of SCSI cables in the chain does not exceed the 236-inch limit. Table 5-1 lists the length of the SCSI cables linking the drives inside each type of expansion box, as well as the lengths of SCSI cables you use to connect the external storage devices to the system unit and to each other. The table is as accurate as possible, but actual lengths may vary by an inch or two.

**Table 5-1. SCSI Cable Lengths**

<b>Cable</b>	<b>Length</b>
Internal cable for BA42 expansion box	31 inches (41 centimeters)
Internal cable for TCE unit	52 inches (133 centimeters)
Internal cable for self-contained storage devices (for devices not listed here, refer to the documentation that came with the device:	
-For TK50Z tape drive	14 inches (36 centimeters)
-For TLZ04 tape drive	37 inches (96 centimeters)
-For RRD42 optical compact disc drive	6.5 inches (16 centimeters)
System-unit-to-expansion-box cable (68-pin to 50-pin)	38 inches (88 centimeters)
System-unit-to-TCE cable (68-pin to 68-pin)	26 inches (60 centimeters)
SCSI box-to-box cable (50-pin to 50-pin)	26 inches (66 centimeters)
Expansion-box-to-TCE cable (50-pin to 68-pin)	38 inches (88 centimeters)

## Checking and Setting SCSI ID Numbers

Each storage device in a group must have a SCSI ID, which the workstation uses to identify the device. The SCSI ID for each drive must

- Be a number from 0 to 6. The numbers do not have to be consecutive.
- Be used only once for each group of drives connected to a single SCSI connector on the system unit.

### To Check the SCSI ID

The SCSI ID for a single drive in its own box is usually displayed in a small window on the back of the box. Table 5-2 lists the usual SCSI ID numbers assigned to drives preinstalled at Digital Equipment Corporation in BA42 or TCE expansion boxes.

**Table 5-2. Usual SCSI ID Assignments for External Drives**

Type of External Drive	Usual SCSI ID Number
Hard disk drive	0
Hard disk drives in a multi-drive expansion box	0 and 1
Diskette drive	4
Optical compact disc drive	4
Tape drive	5

You can use the `cnfg` command to check the SCSI ID of a specific drive. Connect the device to a SCSI connector on the system unit to which no other devices are connected. Then follow the instructions "Testing External Storage Devices" on page 5-17.

## To Set the SCSI ID

The SCSI IDs on most storage devices are preset to numbers that make it easy to connect different types of drives to the same SCSI connector without repeating SCSI IDs. However, the drives that you want to connect might have the same SCSI ID. If this happens, you must change the SCSI ID on those drives that repeat a SCSI ID number.

On some drives, such as the RRD42 optical compact disc, you set the SCSI ID by pushing a button to increment or decrement the number displayed in the SCSI ID window. On other drives, you set the SCSI ID by setting toggle switches on the back of the drive. For more information about how to set the SCSI ID on a specific drive, see the user's guide that came with that device.

Table 5-3 lists the SCSI ID switch positions you should use to set the SCSI ID to any number from 0 to 6 on drives installed in expansion boxes.

**Table 5-3. SCSI ID Switch Settings**

SCSI ID	Hard Disk Drives or Compact Disc Drives	Tape Drives <sup>1</sup>
6	Up Up Down	Down Down Up
5	Up Down Up	Down Up Down
4	Up Down Down	Down Up Up
3	Down Up Up	Up Down Down
2	Down Up Down	Up Down Up
1	Down Down Up	Up Up Down
0	Down Down Down	Up Up Up

<sup>1</sup>Switch 1 (the left switch) on the TLZ04 tape drive should always be in the down position.



## Testing External Storage Devices

1. Turn on the system unit.

When the system unit has completed the power-up self-test successfully, type **cnfg 3** and press Return.

A display that describes the SCSI connector and the drives attached to it then appears on the monitor. This is a portion of a sample display for the base system SCSI controller (slot 3).

```
>>cnfg 3
3:  KN03-AA   DEC   X2.0d   TCF0   (224 MB,   1 MB NVRAM)
                                     (enet: 08-00-2b-0f-45-72)
                                     (SCSI = 7)
```

DEV	PID	VID	REV	SCSI DEV
rz0	RZ55 (C) DEC	DEC	0700	DIR
rz1	RZ24 (C) DEC	DEC	0700	DIR
rz4	RRD42 (C) DEC	DEC	0700	CD-ROM
tz5				SEQ

- a. Look in the column labeled SCSI DEV for a coded description of the type of drive (in this example, DIR, CD-ROM, and SEQ).
- b. Look in the column labeled PID for a coded description of the part ID number (in this example, RZ55, RZ24, and RRD42).
- c. Look in the column labeled DEV for the device code and SCSI ID for each of the drives connected to the base system SCSI connector (in this example, rz0, rz1, rz4, and tz5). The last character of the code is the SCSI ID. The drives in this example have the SCSI IDs 0, 1, 4, and 5.
- d. Check the slot configuration display to see if the system recognizes all of the drives in the external storage devices you connected to the SCSI connector in that slot.

Table 5-4 lists the device codes, device descriptions, and types of drives you may see in your slot configuration display.

Table 5-4. Device Codes for Different Types of SCSI Drives

Device Code (DEV)	Device Description (SCSI DEV)	Type of Drive
rx	DIR	Diskette
rz	CD-ROM	Optical compact disc
rz	DIR	Hard disk
tz	SEQ	Tape

2. If you have any external storage devices attached to a SCSI connector in a TURBOchannel option slot, type **cnfg slot-number**, replacing *slot-number* with the number of the option slot (0, 1, or 2) you want to check.

Then check for the presence of all drives connected to that slot, as described in the previous step.

If an expansion box that you installed fails to appear in the configuration display,

- Be sure that all cables are securely connected and a terminator has been installed on the unused connector on the last box.
- Be sure that each drive in the chain has a different SCSI ID number.
- Be sure that the expansion box is connected to an active power source and switched on.

## Removing an External Storage Device

The following steps tell you how to remove a self-contained storage device or a drive expansion box.

1. Shut down the software.
2. Turn off all system hardware. First turn off the expansion boxes and other external devices. Then turn off the monitor. Then turn off the system unit.
3. Disconnect the expansion box that you are removing.  
If the box is in the middle of a chain of devices, be sure to reconnect all of the remaining devices. Be sure that a terminator is on the unused connector of the last device on the chain.
4. Turn the system hardware on again. First turn on the drive expansion boxes and other external devices. Next, turn on the monitor. Then turn on the system unit.
5. Use the `cnfg` command to test the slot from which you removed the expansion box.

## Installing a Drive in an Expansion Box

To install a drive in a BA42 storage expansion box, see the *BA42 Storage Expansion Box Installation Guide* for directions.

To install a drive in a TCE unit, see the *TURBOchannel Extender Operator's Guide* for directions.

---

## Optional Network Connections

This chapter explains

- Where your workstation's Ethernet connector is located
- When to use, how to install, and how to remove an Ethernet loopback connector
- How to operate the sliding lock on the Ethernet connectors
- How to connect your workstation to ThickWire, ThinWire, and twisted-pair Ethernet networks
- How to find the Ethernet station address for your workstation

## Locating Your Workstation Ethernet Connector

The basic workstation comes with one ThickWire Ethernet connector built into the base system unit for attaching to a single Ethernet network. You can connect the workstation to more than one Ethernet network if you have additional ThickWire Ethernet connectors in any of the TURBOchannel option slots. (For instructions on how to install TURBOchannel ThickWire Ethernet modules, refer to your TURBOchannel user documentation.) The illustrations in this guide show the Ethernet connector on the base system unit.

## Installing and Removing an Ethernet Loopback Connector

Every Ethernet connector must be either connected to an Ethernet cable or terminated with an Ethernet loopback connector in order for your workstation to function correctly.

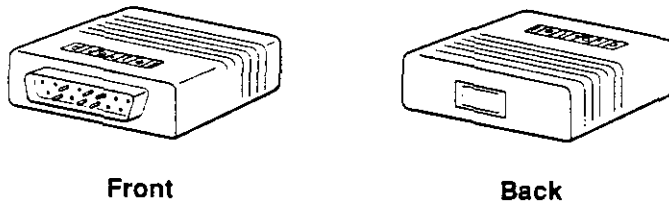

WS3PO079

Figure 6-1. ThickWire Ethernet loopback connector

If your workstation is *not* connected to an Ethernet network, you need to put an Ethernet loopback connector on the base system Ethernet connector and on any Ethernet connectors you may have in the TURBOchannel option slots.

When you connect the workstation to a network, you must remove the loopback connector.

Figure 6-2 shows how to attach and remove an Ethernet loopback connector. When attaching it, hold the connector so the widest part of the metal rim is uppermost and matches the connector on the system unit.

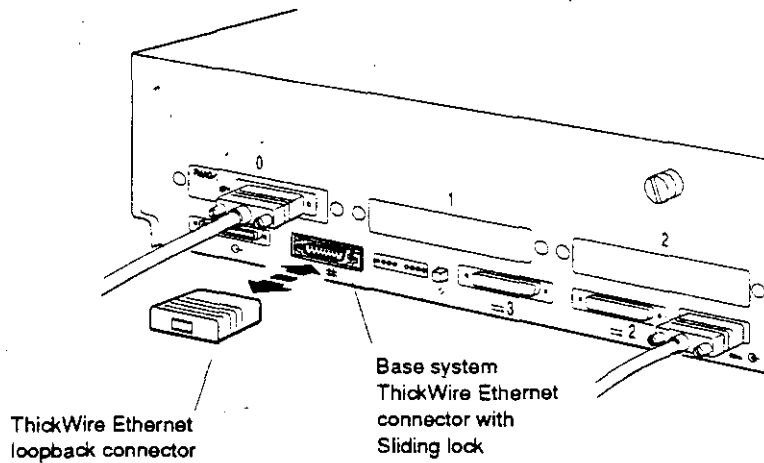

WS3PO044

**Figure 6-2. Installing and removing an Ethernet loopback connector**

## **Operating the Ethernet Connector Sliding Lock**

There is a sliding lock on the ThickWire Ethernet connector on the base system and on each Ethernet option module that may be installed in the TURBOchannel option slots. There is also a sliding lock on one end of the ThickWire Ethernet cable that connects your workstation to the Ethernet network. The following instructions explain how to operate the sliding lock mechanism.

- To unlock the sliding lock on the system unit Ethernet connector or on a ThickWire Ethernet cable, slide the lock in the direction of the small, u-shaped notch. (On the system unit, push the lock to the right with a flat-blade screwdriver. On the cable, push the lock either left or right toward the small notch, depending on the way the lock is mounted.)

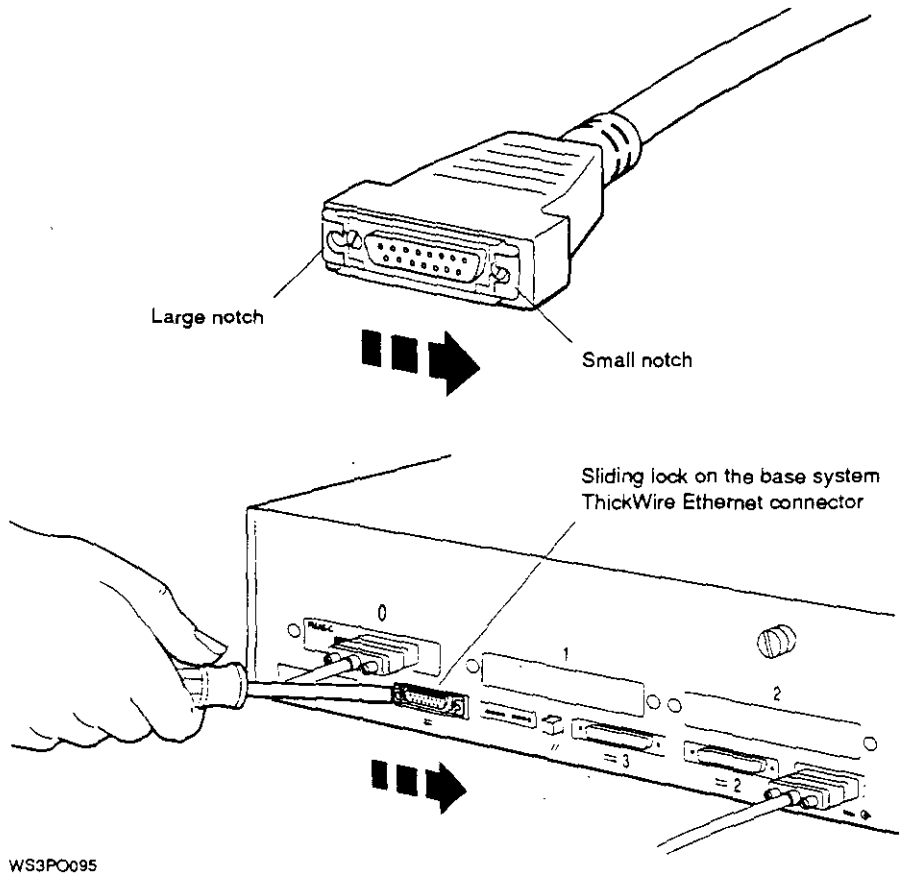

WS3PO095

**Figure 6-3. Unlocking the Ethernet sliding lock**

- To lock the sliding lock on the system unit Ethernet connector or on a ThickWire Ethernet cable, push the protruding edge of the lock toward the center of the connector until it clicks into place. Check to make sure the cable is locked securely in place before proceeding.

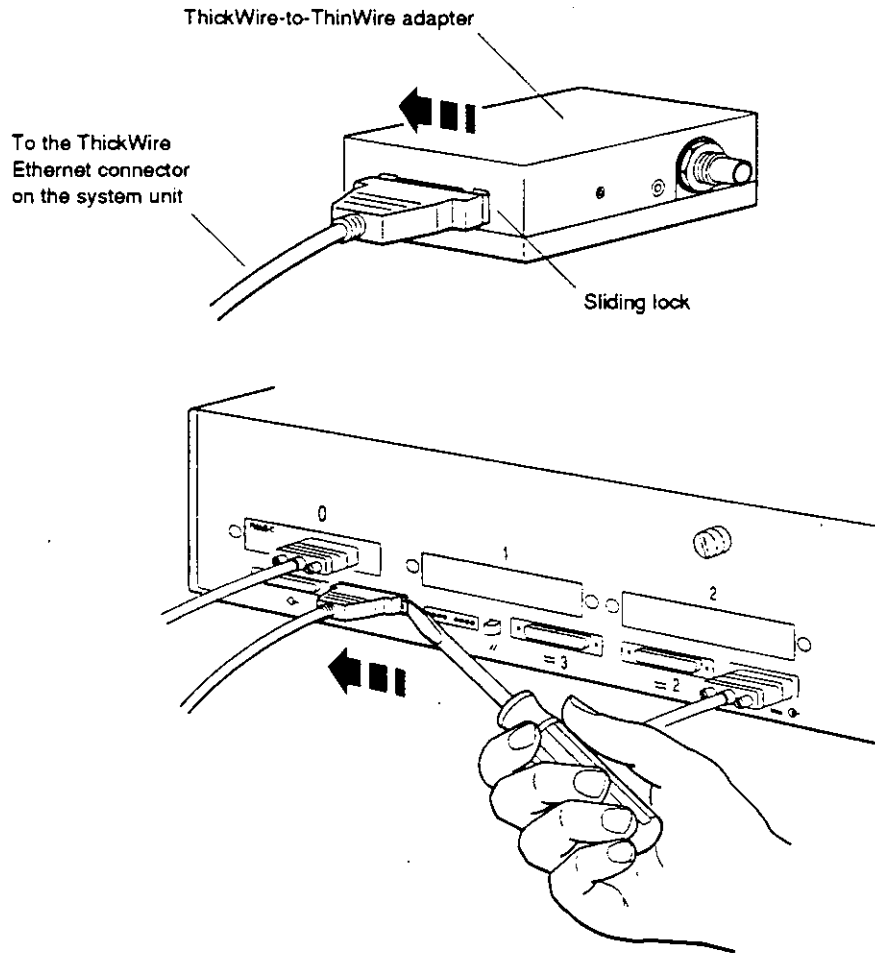

WS3PO094

Figure 6-4. Locking the Ethernet sliding lock



## Finding Your Ethernet Station Address

Every Ethernet connector has a built-in controller. That controller has a unique ID called an Ethernet station address. The system manager needs the Ethernet address (or addresses) for your workstation in order to complete the network connection for you. You need to find and report the Ethernet station address for each Ethernet controller on your workstation, using the following procedure.

1. At the workstation console prompt (>>), type **cnfg** and press Return. A display similar to the following appears on the screen:

```
>>cnfg
3:  KN03-AA  DEC  X2.0d  TCF0  (224 MB, 1 MB NVRAM)
                                     ①
                                     (enet: 08-00-2b-0f-45-72)
                                     (SCSI = 7)
0:  PMAG-BA  DEC  V5.3d  TCF0  (CX -- d=8)
1:  PMAD-AA  DEC  V5.3d  TCF0  (enet: 08-00-2b-0f-45-31)
>>
```

The 3: at the extreme left on the first line indicates that the information that follows is for slot 3, the base system unit. Look at the second line of the display. The entry after `enet:` within the parentheses is the Ethernet station address for the base system, slot 3.

The 0: and the 1: at the extreme left indicate that the information that follows is for TURBOchannel option slots 0 and 1.

In this display, both lines 3: and 1: show Ethernet station addresses.

- ① The Ethernet address for the Ethernet controller in base slot 3 is 08-00-2b-0f-45-72.
  - ② The Ethernet address for the Ethernet controller in option slot 1 is 08-00-2b-0f-45-31.
2. Write down the Ethernet address for each Ethernet controller to be connected to a network. Report the addresses to your system manager and ask the manager to complete the Ethernet connections for you.

## Connecting the Workstation to an Ethernet Network

A workstation can only be connected to your in-house Ethernet network by a system manager or other authorized personnel.

*Caution: Attempting to connect your workstation to the network without prior authorization and proper precautions can result in the loss of data being transmitted to or from other workstations on the network.*

You can remove the Ethernet terminator and connect one end of the ThickWire Ethernet cable to your workstation, as well as any ThinWire or twisted-pair adapters, without completing the connection to your in-house network. However, your workstation will not function properly until it is connected to the network, once the Ethernet terminator is removed.

To connect the workstation to a ThickWire Ethernet network, see the following section, "To Connect a ThickWire Ethernet Cable."

To connect the workstation to a ThinWire or Twisted-pair Ethernet network, start with the section, "To Connect a ThickWire Ethernet Cable." Then follow the directions to connect a ThinWire Ethernet adapter on page 6-11 or a twisted-pair Ethernet adapter on page 6-15.

## To Connect a ThickWire Ethernet Cable

1. Obtain the Ethernet station address for the workstation from the workstation user.
2. Find the ThickWire Ethernet cable that was ordered for the workstation. Notice that one end of the cable has a sliding lock on it and the other does not.
3. Follow the instructions that came with the worksystem software to shut down the software.
4. Turn off the system unit by pressing the 0 on the on/off switch on the back of the unit. Leave the power cord plugged in.

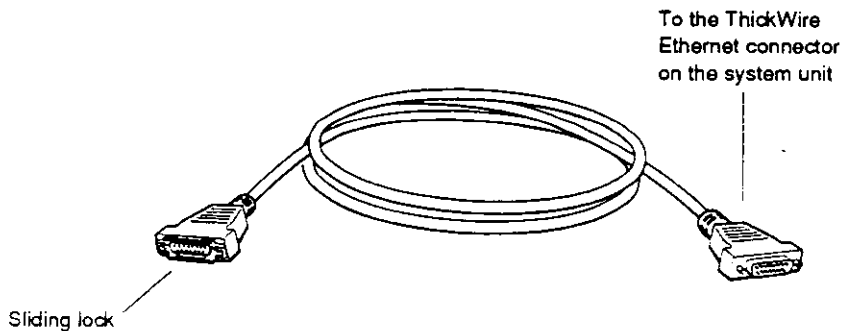

WS3PO047

Figure 6-5. ThickWire Ethernet cable

5. Remove the loopback connector (if present) from the Ethernet connector on the system unit (see Figure 6-2 on page 6-3).
6. Position the cable connector that does *not* have the sliding lock so the widest part is on top.

Push the connector directly onto the base system ThickWire Ethernet connector.

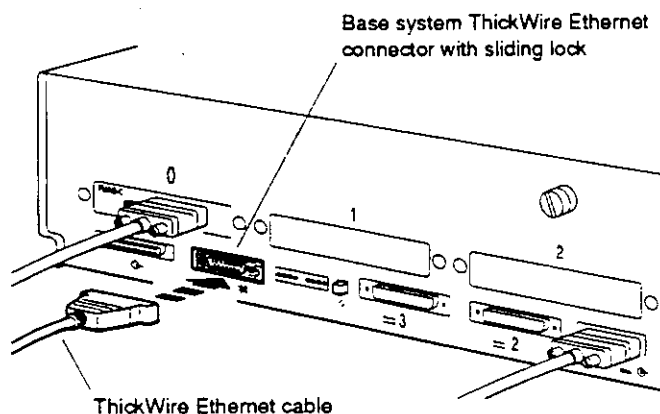

WS3PO048

**Figure 6-6. Connecting a ThickWire Ethernet cable to the system unit**

7. Slide the lock on the system unit Ethernet connector to the locked position (see Figure 6-4 on page 6-5).
8. If connecting the workstation to a ThinWire network, continue with the instructions, "To Connect a ThinWire Ethernet Adapter" on page 6-11.

If connecting the workstation to a twisted-pair network, continue with the instructions, "To Connect a Twisted-Pair Ethernet Adapter" on page 6-15.

If connecting the workstation to a ThickWire network, continue with step 9.

9. Put Ethernet loopback connectors on all unused Ethernet connectors you may have in the TURBOchannel option slots (see Figure 6-2 on page 6-3).
10. Then do one of the following:
  - If you are connecting the workstation to a ThickWire network, contact your system manager or, if authorized to do so, follow your in-house procedures to finish connecting the workstation to the network when the network is not active. Your workstation will not operate properly with an unterminated Ethernet cable until it is connected to the network.
  - If you are connecting the workstation to a ThinWire network, continue with the instructions "To Connect a ThinWire Ethernet Adapter" on page 6-11.
  - If you are connecting the workstation to a twisted-pair network, continue with the instructions "To Connect a Twisted-Pair Ethernet Adapter" on page 6-15.

## To Connect a ThinWire Ethernet Adapter

You connect a DECstation 5000 Model 240 workstation to the ThinWire Ethernet network cable using the ThickWire-to-ThinWire adapter.

1. Follow the instructions "To Connect a ThickWire Ethernet Cable" on page 6-8.
2. Find the ThickWire-to-ThinWire adapter, the T-connector, and the T-connector terminator that you ordered for your workstation.

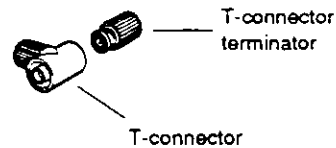
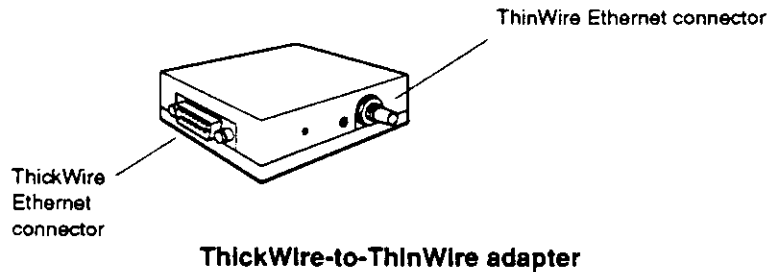

WS3PO078

**Figure 6-7. Parts used to connect a workstation to a ThinWire network**

3. Find the connector with the sliding lock on the other end of the ThickWire Ethernet cable you connected to your workstation.

Make sure the sliding lock on the cable connector is in the unlocked position (see Figure 6-3 on page 6-4).

4. Hold the ThickWire-to-ThinWire adapter and the free end of the ThickWire cable so that the connectors match. Push the ThickWire cable connector with the sliding lock onto the ThickWire connector on the adapter.
5. Slide the lock on the cable attached to the adapter to the locked position (see Figure 6-4 on page 6-5).

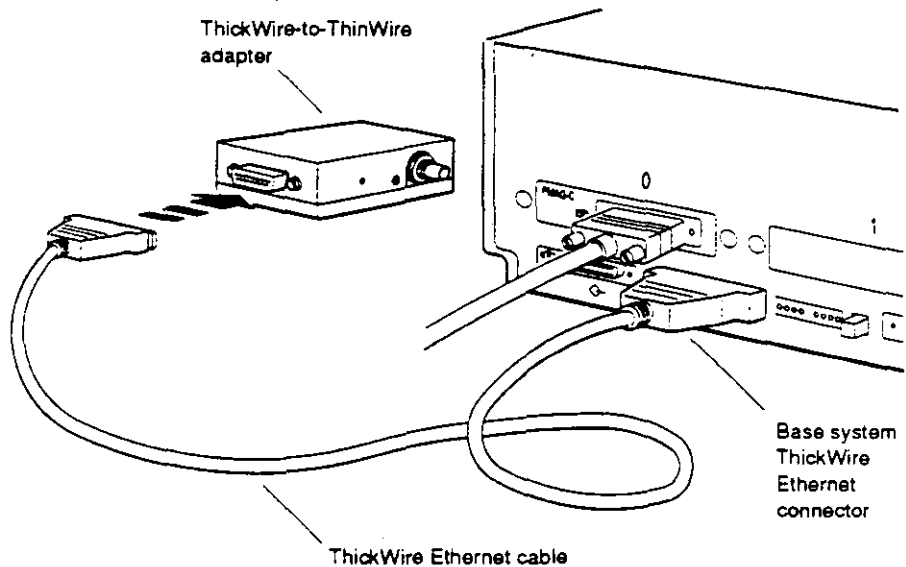

WS3PO089

**Figure 6-8. Connecting a ThickWire cable to the ThinWire adapter**

6. Attach the T-connector to the ThinWire Ethernet connector on the adapter.

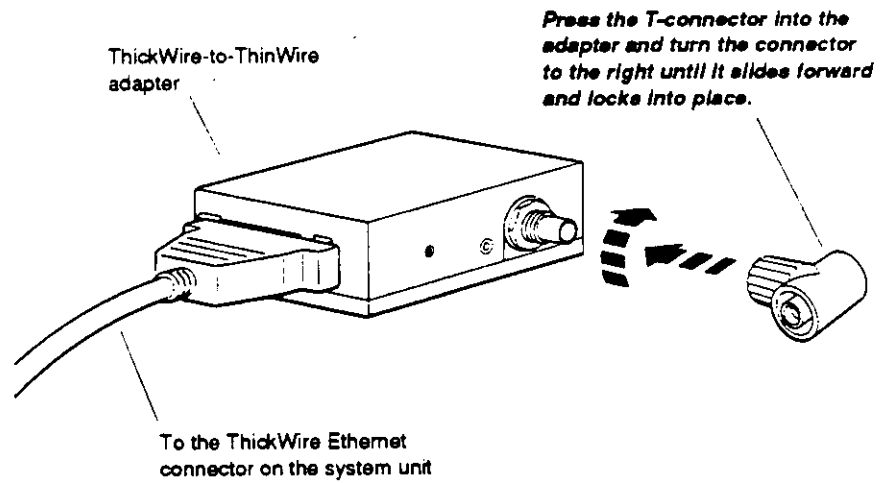
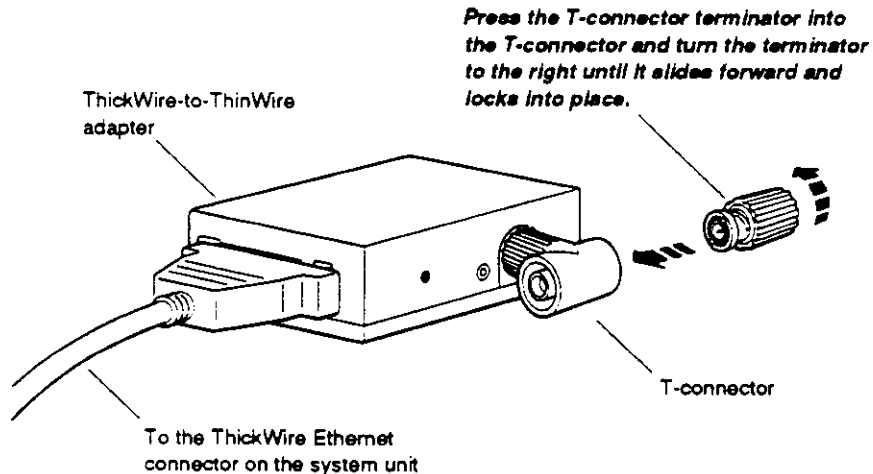

Figure 6-9. Attaching a T-connector



7. If you are connecting the workstation *within* a network cable segment, leave both ends of the T-connector free to attach your in-house network cables.

If you are connecting the workstation at the *end* of a network cable segment, attach a T-connector terminator to the open end of the T-connector on the adapter.



WS3PO093

Figure 6-10. Attaching a T-connector terminator

8. Put an Ethernet loopback connector on all unused Ethernet connectors you may have in the TURBOchannel option slots (see Figure 6-2 on page 6-3.)
9. Contact your system manager or, if authorized to do so, follow your in-house procedures to finish connecting the workstation to the ThinWire network when the network is not active. Your workstation will not operate properly with an unterminated ThinWire adapter until it is connected to the network.

## To Connect a Twisted-Pair Ethernet Adapter

You connect a DECstation 5000 Model 240 workstation to an unshielded twisted-pair Ethernet network using a ThickWire-to-twisted-pair adapter.

1. Follow the instructions "To Connect a ThickWire Ethernet Cable" on page 6-8.
2. Find the ThickWire-to-twisted-pair adapter and the twisted-pair Ethernet cable that you ordered for your workstation.



Twisted-pair Ethernet cable

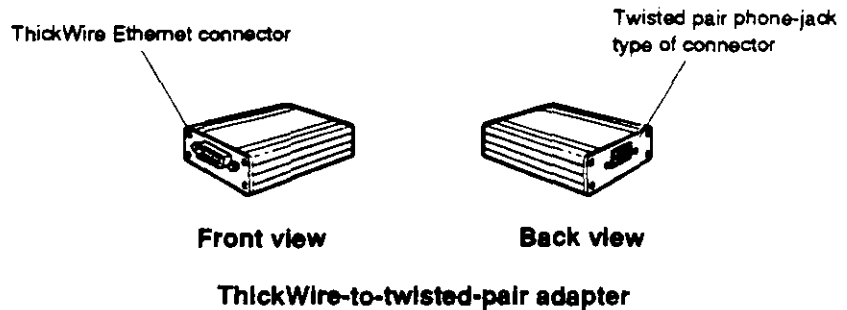

WS3PO077

Figure 6-11. Parts used to connect a workstation to a twisted-pair Ethernet network

3. Find the connector with the sliding lock on the other end of the ThickWire Ethernet cable you connected to your workstation.

Make sure the sliding lock on the cable connector is in the unlocked position (see Figure 6-3 on page 6-4).

4. Hold the ThickWire-to-twisted-pair adapter and the free end of the ThickWire cable so that the connectors match up. Push the ThickWire cable connector with the sliding lock onto the ThickWire connector on the adapter.

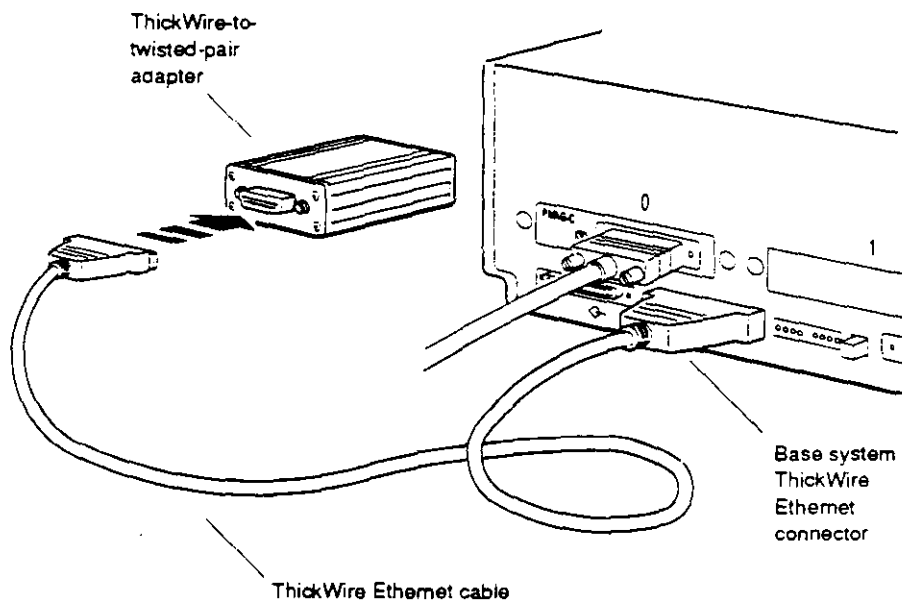

WS3PO087

**Figure 6-12. Connecting the ThickWire-to-twisted-pair-adapter**

5. Slide the lock on the cable attached to the adapter to the locked position (see Figure 6-4 on page 6-5).
6. Find the twisted-pair Ethernet cable that you ordered for your workstation. Notice that the telephone-jack type of connectors at both ends are identical.

7. Push one of the connectors on the twisted-pair Ethernet cable into the telephone-jack type of connector on the adapter until it clicks into place.

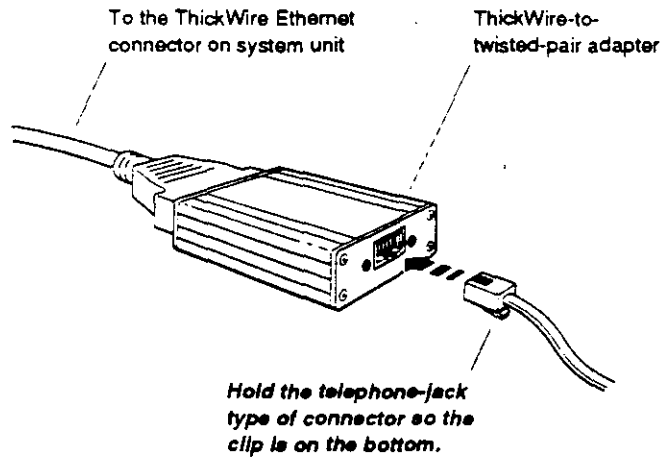

WS3PO076

**Figure 6-13. Connecting the twisted-pair cable to the twisted-pair adapter**

8. Put Ethernet loopback connectors on all unused Ethernet connectors you may have in the TURBOchannel option slots (see Figure 6-2 on page 6-3.)
9. Contact your system manager or, if authorized to do so, follow your in-house procedures to finish connecting the workstation to the twisted-pair network when the network is not active. Your workstation will not operate properly with an unterminated twisted-pair adapter until it is connected to the network.

---

## External Communications Options

This chapter explains

- How to connect a communications device directly to the system unit
- How to use a communications connector adapter
- How to install a terminal as an alternate system console

## External Communications Options

Communications devices that can be used with your DECstation 5000 Model 240 workstation include printers, plotters, modems, and console terminals.

Two synchronous/asynchronous RS232 serial communications ports with 25-pin connectors are located on the back of the system unit.

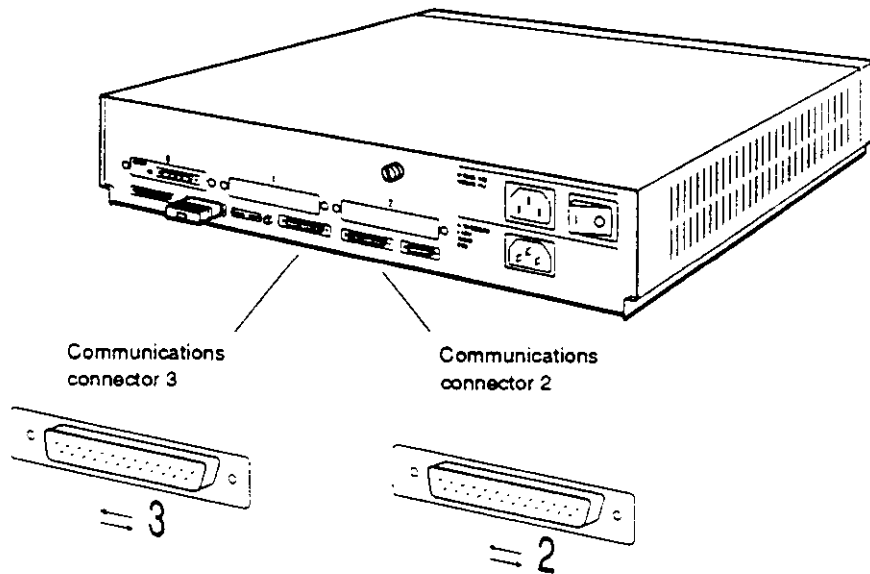

WS3PO052

Figure 7-1. Communications connectors on the system unit

When a terminal is configured as the system console, it occupies one of the communications ports, leaving the other free for an optional serial peripheral device such as a printer, plotter, or modem.

The baud rate of each serial line is independently programmable. The rate can be set at 50 to 204,200 bits per second. The default rate is 9600 baud.

## Types of Connectors

Communications devices used with your workstation have two types of connectors:

- 25-pin connector, which can be attached directly to the serial communications ports on the system unit
- Modular connector, which requires a communications connector adapter before it can be connected to the system unit

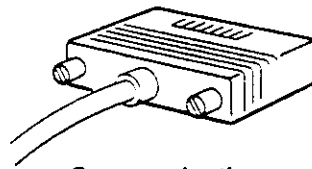

**Communication  
device cable  
connector**

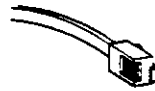

**Modular  
connector**

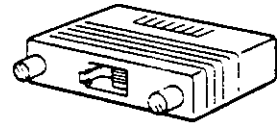

**Communications  
connector  
adapter**

WS3PO053

**Figure 7-2. Communications device connectors and an adapter**

## Installing a Device with a 25-Pin Connector

You can connect 25-pin communication connectors directly to the system unit.

1. Follow the instructions that came with your device to do these tasks:
  - Be sure the device is turned off.
  - Set up the device and attach the cable and power cord that came with it.
  - Set the proper baud rate and control settings on the device and in the worksystem software, if appropriate.
2. Follow the instructions that came with your worksystem software to shut down the software.
3. Turn off the system unit by pressing the 0 on the on/off switch on the back of the unit.
4. Connect the end of the communications device cable to the system unit as shown in Figure 7-3. The connectors are shaped so that they go together only one way.

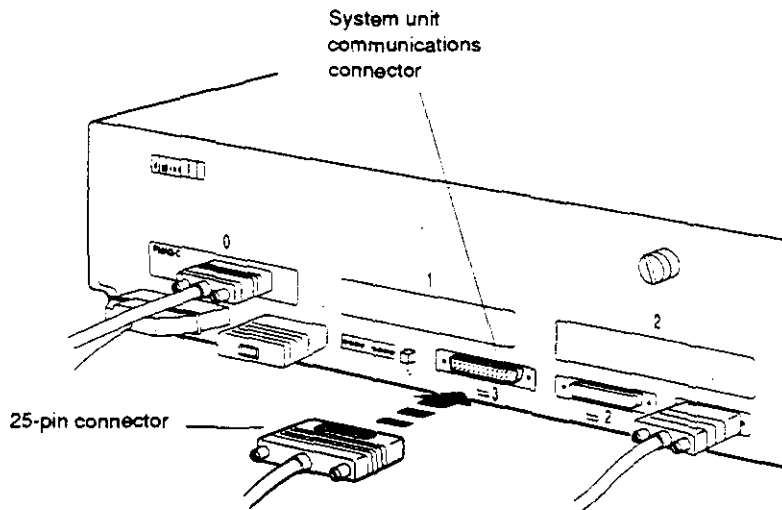

WS3PC054

**Figure 7-3. Connecting a communications device with a 25-pin connector**



5. Plug the power cord into the power outlet.
6. Turn on the communications device.
7. Turn on the system unit by pressing the 1 on the on/off switch on the back of the unit.

The workstation performs either the quick or the full automatic power-up self-test, depending on how the testaction environment variable has been set. (For information about setting the testaction environment variable or about the power-up self-test, see "Testing Your Workstation" on page 3-6.)

8. If your workstation ran the quick rather than the full power-up self-test, type **test** at the console prompt (>>) and press Return. The workstation will then run the complete system self-test.
9. If any part of the self-test fails, the system displays an error message. Turn to Chapter 11 for troubleshooting instructions.

## Installing a Device with a Modular Connector

To install a device with a modular (telephone-jack type) connector, you need a 25-pin communications adapter.

1. Follow the instructions in the documentation that came with your communications device to perform these tasks:
  - Be sure the device is turned off.
  - Set up the device and attach the cable and power cord that came with it.
  - Set the proper baud rate and control settings on the device and in the worksystem software, if appropriate.
2. Follow the instructions that came with your worksystem software to shut down the software.
3. Turn off the system unit by pressing the 0 on the on/off switch on the back of the unit.
4. Find the communications connector adapter that came with your shipment (see Figure 7-2 on page 7-3).
5. Hold the adapter so the widest part of the connector is on top. Press the 25-pin connector on the adapter into one of the communications connectors on the system unit and tighten the screws as shown in Figure 7-4 on page 7-7.

6. Hold the modular connector on the communications device cable so the clip is on your left. Push the modular connector into the adapter until the connector clicks into place.

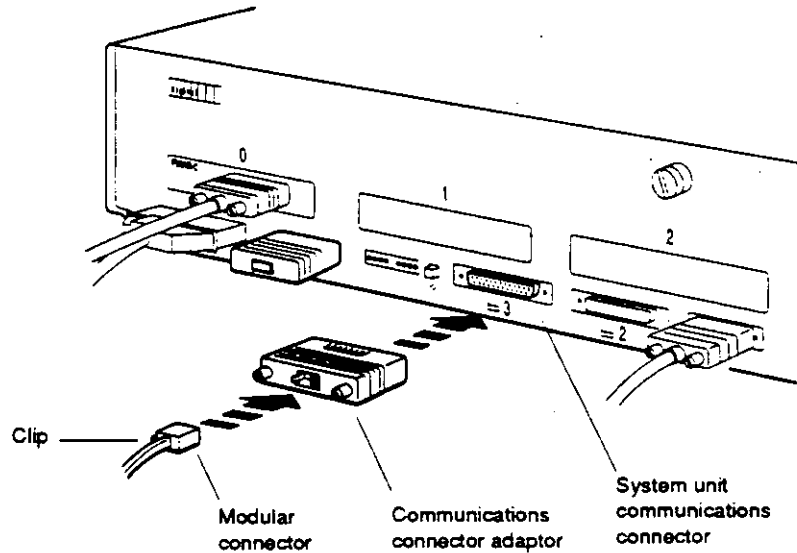

WS3PO055

**Figure 7-4. Using an adapter to connect a communications device with a modular connector**

7. Plug the power cord into the power outlet.
8. Turn on the communications device.

9. Turn on the system unit by pressing the 1 on the on/off switch on the back of the system unit.

The workstation performs either the quick or the full automatic power-up self-test, depending on how the `testaction` environment variable has been set. (For information about setting the `testaction` environment variable or about the power-up self-test, see "Testing Your Workstation" on page 3-6.)

10. If your workstation ran the quick rather than the full power-up self-test, type `test` at the console prompt (`>>`) and press Return. The workstation will then run the complete system self-test.
11. If any part of a self-test fails, the system displays an error message. Turn to Chapter 11 for troubleshooting instructions.

# **Part III**

---

## **Internal Parts and Additions to Your Workstation**

---

## Inside the System Unit

This chapter explains

- What user-replaceable parts are inside the system unit
- How to improve workstation performance by adding internal options
- How to remove and replace the cover of the system unit
- How to use the antistatic wrist strap

## Main Parts of the System Unit

The system unit enclosure contains

- Base system module
- Memory modules
- Central processing unit (CPU) module
- TURBOchannel option modules, if any
- Power supply

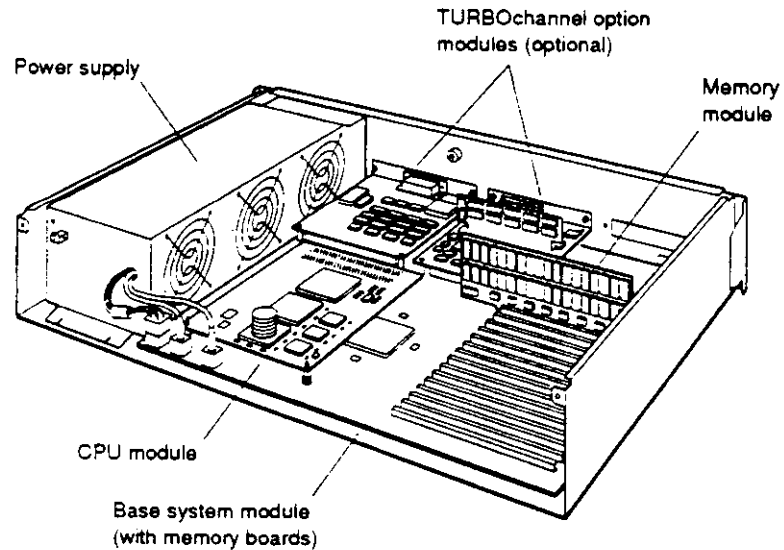

WS3PO012

Figure 8-1. Inside of the system unit enclosure

You can improve your workstation's performance by replacing or adding the following internal options:

- Memory modules
- Nonvolatile random-access memory (NVRAM) module
- CPU module
- TURBOchannel option modules

## The Base System Module

The base system module contains

- CPU module slot
- 15 memory module slots
- 256 kilobyte power-up self-test and bootstrap read-only memory (ROM)
- System control and status registers
- System clock and 50-byte battery-backed-up random-access memory (RAM)
- Two synchronous/asynchronous RS232 serial communication ports
- Serial line interface for keyboard and mouse or other pointing device
- Network interface for ThickWire Ethernet
- Small computer system interface (SCSI-2) for up to seven devices
- 3 TURBOchannel option slots
- Interrupt halt switch

## Memory Modules

Your workstation comes with at least 16 megabytes of memory. The amount of memory can vary, depending on what memory modules you ordered for your workstation. The memory modules plug into the memory slots on the base system module. You can expand your workstation's memory to a total of 480 megabytes by installing up to fifteen 8-megabyte (MS02-AA) or fifteen 32-megabyte (MS02-CA) single in-line memory modules (SIMMS). All memory modules in your system unit must be the same type and have the same capacity. See Chapter 9 for instructions on installing memory modules.



## **Nonvolatile Random-access Memory (NVRAM) Module**

Your workstation optionally comes with 1 megabyte of nonvolatile random-access memory (NVRAM). NVRAM provides a battery-backed-up memory disk cache that retains data during a power failure and improves workstation performance. The NVRAM module plugs into the last memory module slot on the base system module. See Chapter 9 for instructions on installing an NVRAM module.

## **The CPU Module**

The CPU module performs all the data processing functions of the workstation. It plugs into the base system module. You can replace the CPU module to improve workstation performance, as faster CPUs become available.

Your CPU module contains

- 40 MHz central processing unit (CPU) with an R3010 floating-point unit (FPU)
- 64 kilobyte instruction and data cache

For information on installing a CPU module, refer to Chapter 9.

## **TURBOchannel Option Modules**

The system unit has space for up to three TURBOchannel option modules. TURBOchannel option modules can expand the capabilities of your workstation in the following ways:

- Graphics modules allow you to connect one or more monitors to your workstation. Your workstation comes with one graphics option module installed. Graphics modules can be installed in
  - Any TURBOchannel option slot in the system unit
  - A TURBOchannel extender (TCE) unit connected to the system unit
- SCSI controller modules allow you to connect more external storage devices (such as disk, tape, and compact disc drives) to your workstation than the base system SCSI controller can accommodate.

- Ethernet controller modules allow you to connect your workstation to more than one Ethernet network
- Other TURBOchannel option modules allow you to connect special options, such as DECAudio and DECvideo-in, to your workstation

Some TURBOchannel options, including many graphics modules, take up the physical space and power of two or three TURBOchannel option slots, but have only one TURBOchannel address and connector. These TURBOchannel modules are called wide modules. To avoid using more than one slot in your system unit for a double- or triple-wide module, you can install the wide module in a TURBOchannel extender (TCE) unit instead. You connect the TCE to a single-wide TCE option module installed in one of the three TURBOchannel option slots in the system unit. The TCE can contain one wide module (for instance, a graphics module), as well as tape, disk, or compact disc drives.

For more information about TURBOchannel options and how to install them, refer to the *TURBOchannel Options User's Guide*.

### **The Power Supply**

The DECstation 5000 Model 240 workstation has a fully self-contained, 244-watt maximum, fan-cooled power supply. Output voltages are +5.1 volts at 40 amperes, 12.1 volts at 2.7 amperes, and -12.1 volts at 0.2 amperes.

## Removing and Replacing the System Unit Cover

### To Remove the Cover from the System Unit

1. Follow the instructions that came with your worksystem software to shut down the software.
2. Turn off the system unit by pressing the 0 on the on/off switch on the back of the unit.
3. Unplug the system unit power cord.
4. Loosen the cover-release screw on the back of the system unit. This is a captive screw. It can be loosened, but not removed.
5. Stand in front of the system unit, grasp both sides of the cover with your hands, and pull the cover straight toward you about 2 inches (6 centimeters). Then pull up (see Figure 8-2).

*Caution: If your workstation was running prior to removing the system unit cover, wait several minutes for the unit to cool down before touching any of the parts, as they could be hot.*

*Always use an antistatic wrist strap when working inside of the system unit (see "Using the Antistatic Wrist Strap" on page 8-8 for instructions).*

## To Replace the Cover on the System Unit

1. Standing at the front of the system unit, position the cover as shown in Figure 8-2.
2. Place the cover on the system unit about 2 inches (6 centimeters) from the back of the unit. Then slide the cover all the way to the back of the system unit.
3. Press and tighten the cover-release screw on the back of the unit.

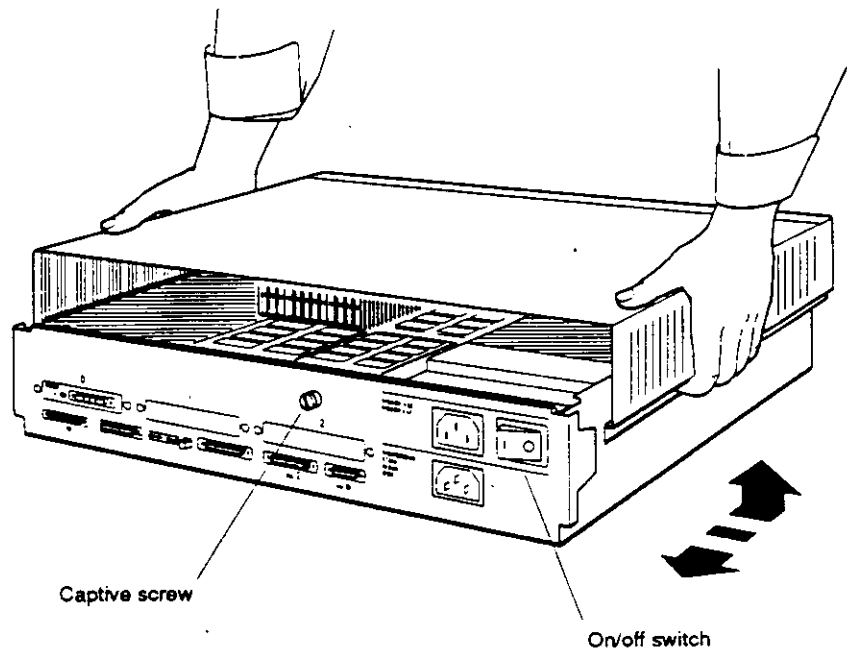

WS3PO037

**Figure 8-2. Removing and replacing the system unit cover**

## Using the Antistatic Wrist Strap

Always use an antistatic wrist strap when you work inside the system unit or with items stored in antistatic bags.

*Caution: Failure to use an antistatic device while handling electrostatically sensitive computer parts can result in reduced reliability or damage to the part.*

1. Find the antistatic wrist band that came with your workstation or with the parts to be installed.
2. Unwrap the first two folds of the wrist band and wrap the exposed adhesive side firmly around your wrist.
3. Unroll the rest of the band and peel the liner from the copper foil at the opposite end.
4. Attach the adhesive copper foil to the metal frame that encloses the system unit.

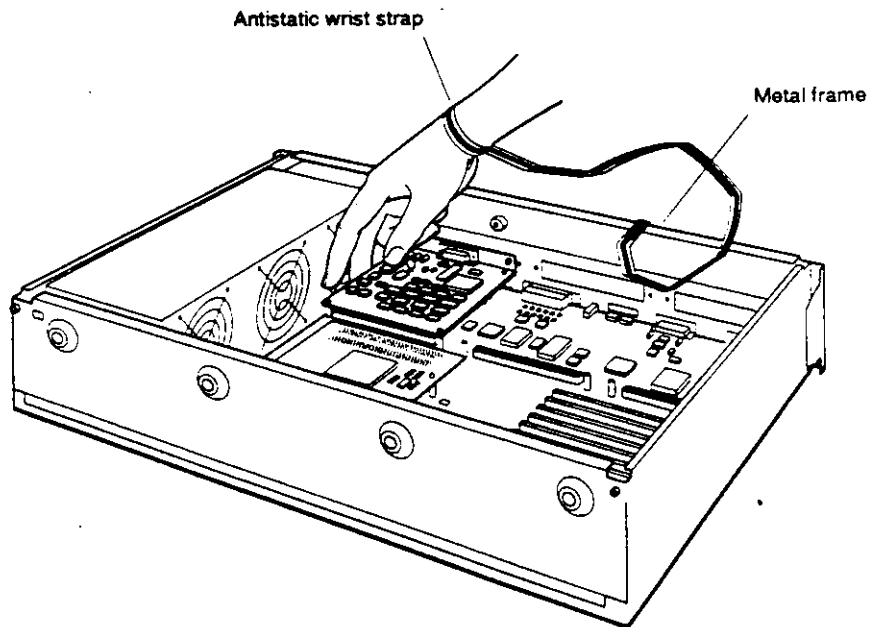

WS3PO036

Figure 8-3. Using an antistatic wrist strap

---

## Installing Internal Option Modules

This chapter explains

- How to install, test, and remove memory modules
- How to install, remove, and test an NVRAM module
- How to replace and test the CPU module
- Where to find information on installing TURBOchannel option modules

## Installing and Removing Memory

DECstation 5000 Model 240 workstations come with at least 16 megabytes of memory. You can add more memory by installing additional memory modules in the memory module slots inside the system unit. Your workstation has 15 memory slots. The first 14 slots (slots 0 to 13) can hold either all 8-megabyte or all 32-megabyte single in-line memory modules (SIMMs). The last slot (slot 14) can hold either another SIMM of the same type or an NVRAM module.

- With 8-megabyte memory modules, you can install up to 120 megabytes of memory.
- With 32-megabyte memory modules, you can install up to 480 megabytes of memory.

When adding memory modules, follow these rules:

- Fill the memory slots in order, starting with slot 0.
- Do not leave an empty slot between two filled slots.
- Use only one type of memory module in your workstation: either the MS02-AA or the MS02-CA.
  - Each MS02-AA module contains 8 megabytes of memory.
  - Each MS02-CA module contains 32 megabytes of memory.

The `cnfg` command shows how much memory is installed in your workstation. Chapter 10 explains how to use the command.

## To Install Memory Modules

To install memory modules, you need a medium Phillips screwdriver.

1. Follow the instructions that came with your worksystem software to shut down the software.
2. Turn off the system unit by pressing the 0 on the on/off switch on the back of the unit. Then unplug the system unit power cord.

*Caution: Allow the unit to cool down several minutes before touching any internal parts, as the parts could be hot.*

3. Remove the cover from the system unit (see "To Remove the Cover from the System Unit" on page 8-6).
4. Attach one end of the antistatic wrist strap to your wrist and attach the other end to the metal frame that encloses the system unit (see "Using the Antistatic Wrist Strap" on page 8-8).
5. Locate the metal bracket that locks the memory modules in place (see Figure 9-1 on page 9-4). Loosen the two screws on the bracket until the bracket can be pulled away from the system unit.



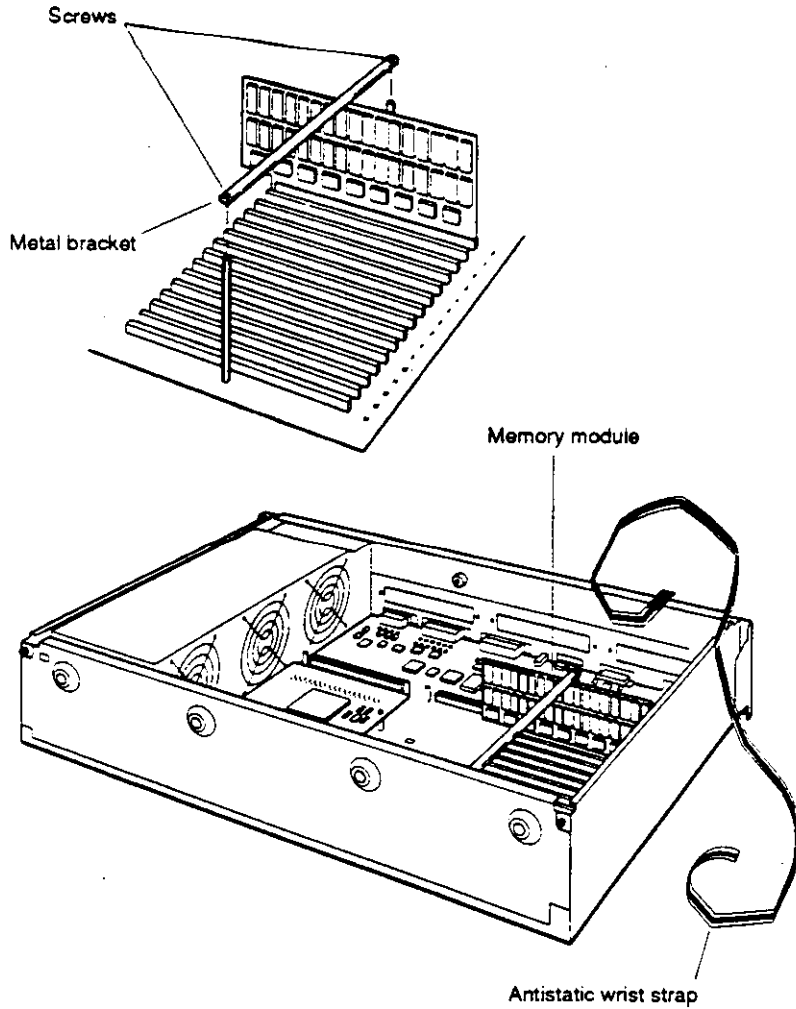

WS3PO038

**Figure 9-1. Releasing the memory module bracket**

6. Unpack a new memory module.

*Caution: Do not touch the contacts along the bottom of the memory module, as this can damage or destroy the module.*

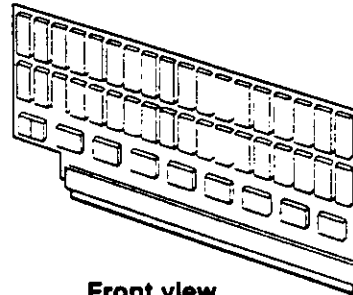

**Front view**

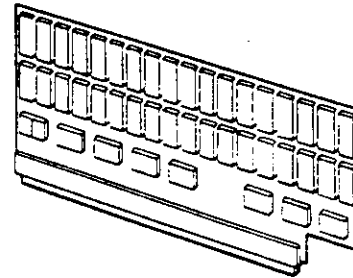

**Back view**

WS3PO039

**Figure 9-2. Memory module**

7. Look at the numbers printed beside the memory slots inside the system unit. Align the connector on the module with the lowest-numbered vacant connector in the system unit. Then push the memory module straight down and all the way into the memory connector on the system unit.

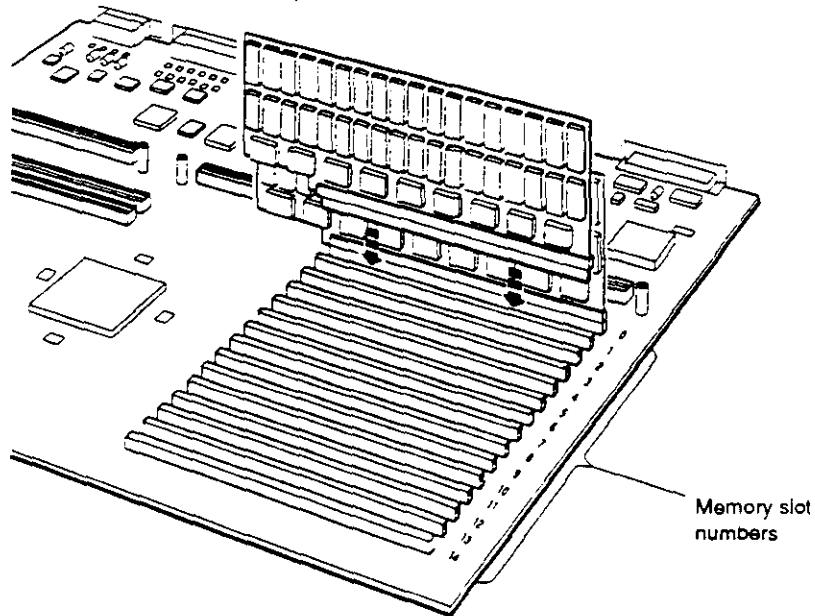

WS3PO040

**Figure 9-3. Memory slots inside the system unit**

8. Repeat the installation for every memory module you are installing. Be sure to install each module in the slot with the lowest number.
9. Replace the metal bracket and the two screws that hold it in place.
10. Remove the antistatic wrist strap from your wrist and from the system unit.
11. Replace the cover on the system unit (see "To Replace the Cover on the System Unit" on page 8-7).

## To Test Memory Modules

1. Turn on the monitor. Then turn on the system unit.

The system unit runs the power-up self-test. For details about the self-test, see Chapter 3.

2. At the console prompt (>>), type one of the following:

- **t 3/mem \*** to test all of the memory modules
- **t 3/mem** followed by a space and the number of a memory slot to test the memory module installed in that slot. For example, to test the module in memory slot 2, type **t 3/mem 2**.

A display similar to the following appears on your screen as the memory test progresses (testing all memory modules can take up to 5 minutes):

```
**\
```

When the test is done, the console prompt (>>) appears. If an error message appears, turn to Chapter 11 for troubleshooting instructions.

3. Type **cnfg 3** at the console prompt and press Return to see the total amount of memory in the workstation. A display like the following appears on your screen:

```
>>cnfg 3
3: KN03-AA DEC X2.0d TCF0 (224 MB, 1 MB NVRAM)
(enet: 08-00-2b-0f-45-72)
(SCSI = 7)

-----
DEV PID VID REV SCSI DEV
-----
rz0 RZ55 (C) DEC DEC 0700 DIR
rz2 RZ24 (C) DEC DEC 0700 DIR
rz4 RRD42 (C) DEC DEC 0700 DIR
tz5 SEQ
dcache( 64 KB), icache( 64KB)
mem( 0): a0000000: a1ffffff ( 32 MB)
mem( 1): a2000000: a3ffffff ( 32 MB)
mem( 2): a4000000: a5ffffff ( 32 MB)
mem( 3): a6000000: a7ffffff ( 32 MB)
mem( 4): a8000000: a9ffffff ( 32 MB)
mem( 5): aa000000: abffffff ( 32 MB)
mem( 6): ac000000: acffffff ( 32 MB)
mem(14): bc000000: bc0fffff ( 1 MB) Presto-NVR
mem(14): clean, batt OK, armed
>>
```

The first number in the parentheses on the first line of the display shows the total amount of memory in your workstation (in this example, 224 megabytes). The lines beginning with `mem` show the amount of memory installed in each memory slot. If the display does not list the correct amount of memory, check to make sure the correct memory modules are installed in the system unit in consecutive slots. If the correct modules are installed, turn to Chapter 11 for troubleshooting instructions.

## To Remove Memory Modules

Follow these rules when you remove memory modules:

- Remove memory modules from one memory slot at a time, always starting with the highest-numbered slot.
- Do not leave an empty slot between memory modules.
- Be sure you have at least 16 megabytes of memory to operate your workstation.

Then proceed as follows:

1. Follow the instructions that came with your worksystem software to shut down the software.
2. Turn off the system unit by pressing the 0 on the on/off switch on the back of the unit. Then unplug the system unit power cord.

*Caution:* Allow the unit to cool down several minutes before touching any internal parts, as the parts could be hot.

3. Remove the cover from the system unit (see "To Remove the Cover from the System Unit" on page 8-6).
4. Attach one end of the antistatic wrist strap to your wrist and attach the other end to the metal frame that encloses the system unit (see "Using the Antistatic Wrist Strap" on page 8-8).
5. Locate the metal bracket that locks the memory modules in place (see Figure 9-4). Loosen the two screws on the bracket until the bracket can be pulled away from the system unit.

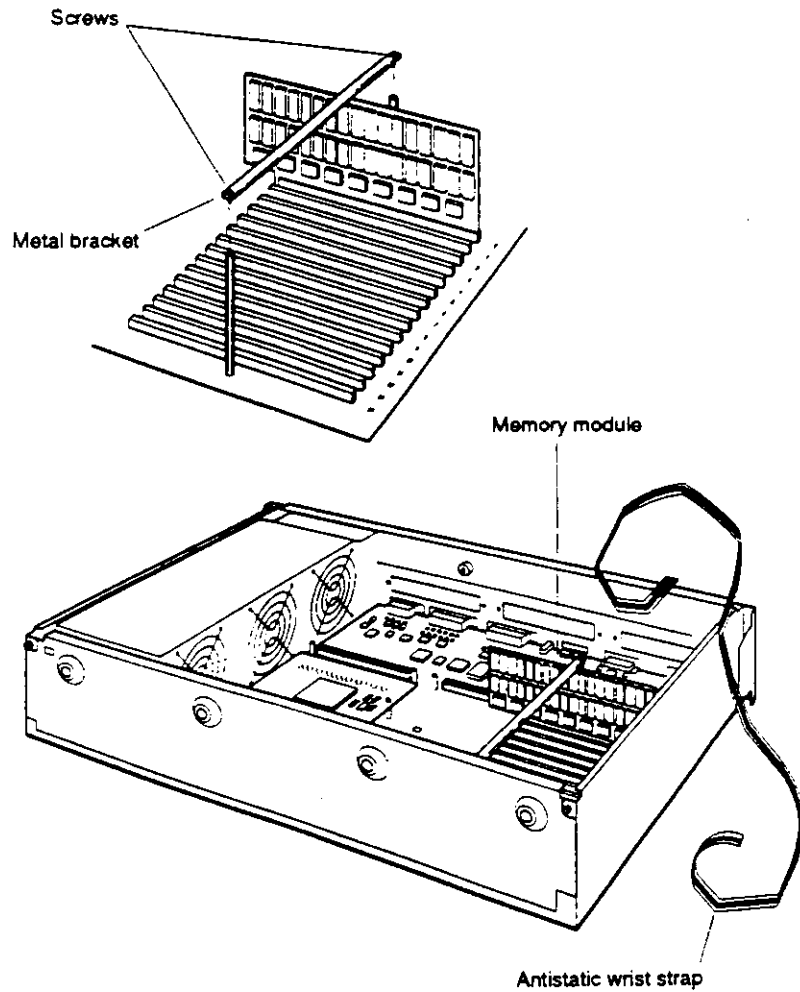

WS3PO038

**Figure 9-4. Releasing the memory module bracket**

6. Locate the memory module in the highest-numbered memory slot and pull that module straight up until it is free of its connector. Store the module in an antistatic bag.

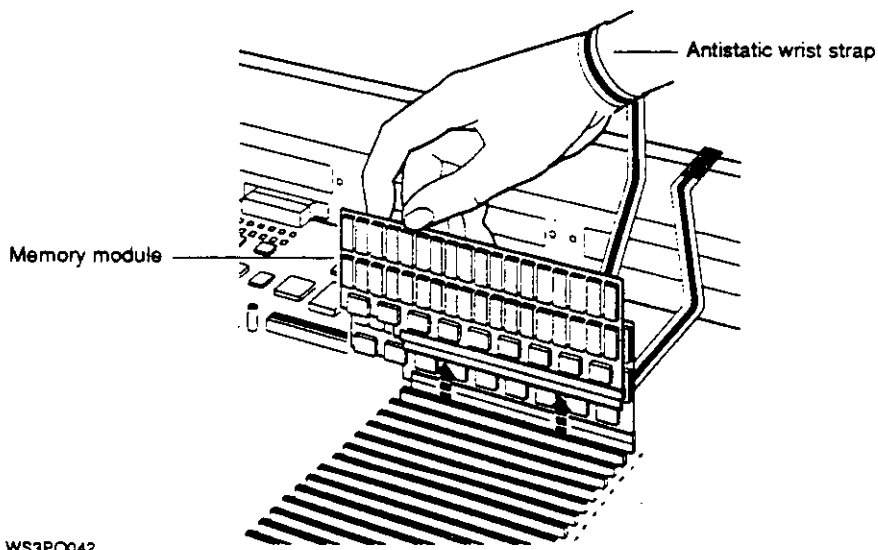

**Figure 9-5. Removing a memory module**

7. Continue removing memory modules until you have removed all that you intend to. (You must have at least 16 megabytes of memory to operate your workstation.) Always remove memory modules from the highest-numbered memory slots first.
8. If you are replacing the existing memory modules with new ones, turn to the section, "To Install Memory Modules," on page 9-3.
9. Replace the metal bracket and tighten the screws.
10. Remove the antistatic wrist strap from the system unit and your wrist and replace the cover on the system unit (see "To Replace the Cover on the System Unit" on page 8-7).

## Installing and Removing a PrestoServe/NVRAM Module

The PrestoServe nonvolatile random-access memory (NVRAM) module is an option you can purchase for your workstation that provides 1 megabyte of battery-backed up memory. The NVRAM module (MS02-NV) can only be installed in memory slot 14 on the base system module. You install and remove an NVRAM module in basically the same way you install and remove memory modules (see "To Install Memory Modules" on page 9-3 and "To Remove Memory Modules" on page 9-8).

To test an NVRAM module,

1. Turn on your workstation.

The system unit runs the power-up self-test. For details about the self-test, see Chapter 3.

When the test is done, the console prompt (>>) appears. If an error message appears, turn to Chapter 11 for troubleshooting instructions.



2. Type **cnfg 3** at the console prompt and press Return. A display like the following appears on your screen (the numbers in the black circles correspond to the explanations in the list that follows):

```
3:  KN03-AA   DEC       X2.0d   TCF0   (64 MB, 1 MB NVRAM) ①
      (enet: 08-00-2b-0f-45-72)
      (SCSI = 7)
```

```
-----
DEV  FID                               VID          REV          SCSI DEV
-----
rz2  RZ55   (C) DEC    DEC          0700        DIR
rz4  RX23   (C) DEC    DEC          0700        DIR
tz1                                     SEQ
```

```
dcache ( 64 KB), icache ( 64 KB)
```

```
mem( 0): a0000000: a1ffffff ( 32 MB) ③
mem( 1): a2000000: a3ffffff ( 32 MB)
mem(14): bc000000: bc0ffffff ( 1 MB) ④ Presto-NVR
mem(14): clean, batt OK, armed ⑤
```

>>

- ① Indicates that 1 megabyte of NVRAM is present in the base system slot (slot 3)
- ② Indicates that the NVRAM module has been installed in memory slot 14
- ③ Indicates the status of the NVRAM module

A clean cache has no data in it, in which case the battery disconnect circuits are armed and the battery is disconnected from the cache, as it is not currently needed. A valid cache has valid data in it, in which case the battery disconnect circuits are unarmed and the battery is connected to the cache to preserve the data in the event of a power failure.

*Caution: Turning the workstation off when battery disconnect circuits are unarmed (NVRAM battery is connected to the cache and the cache is valid) will cause the batteries to drain unnecessarily.*

Turn to Chapter 11 for troubleshooting instructions in any of the following circumstances:

- The system self-test displayed an error message referring to prcache.
- The cnfg 3 display does not list the NVRAM module.
- The cnfg 3 display shows the status of the NVRAM module to be anything other than: clean, batt OK, armed

## Replacing CPU Modules

You may need a flat-blade screwdriver to install a new CPU module.

### To Remove a CPU Module

1. Follow the instructions that came with your worksystem software to shut down the software.
2. Turn off the system unit by pressing the 0 on the on/off switch on the back of the unit. Then unplug the system unit power cord.

*Caution: Allow the unit to cool down several minutes before touching any internal parts, as the parts could be hot.*

3. Remove the cover from the system unit (see "To Remove the Cover from the System Unit" on page 8-6).
4. Attach one end of the antistatic wrist strap to your wrist and attach the other end to the metal frame that encloses the system unit (see "Using the Antistatic Wrist Strap" on page 8-8).
5. Find the CPU module inside the system unit (see Figure 9-6).
6. Locate the lock at the top of one of the mounting posts on the CPU module. Use your fingernails or a pair of small pliers to press the lock into the post while gently pulling up on the corner of the CPU module until it is free of the lock. Do not lift the module completely off the mounting post.
7. Use the same procedure to pull the other corners of the module free of the locks on the other mounting posts.

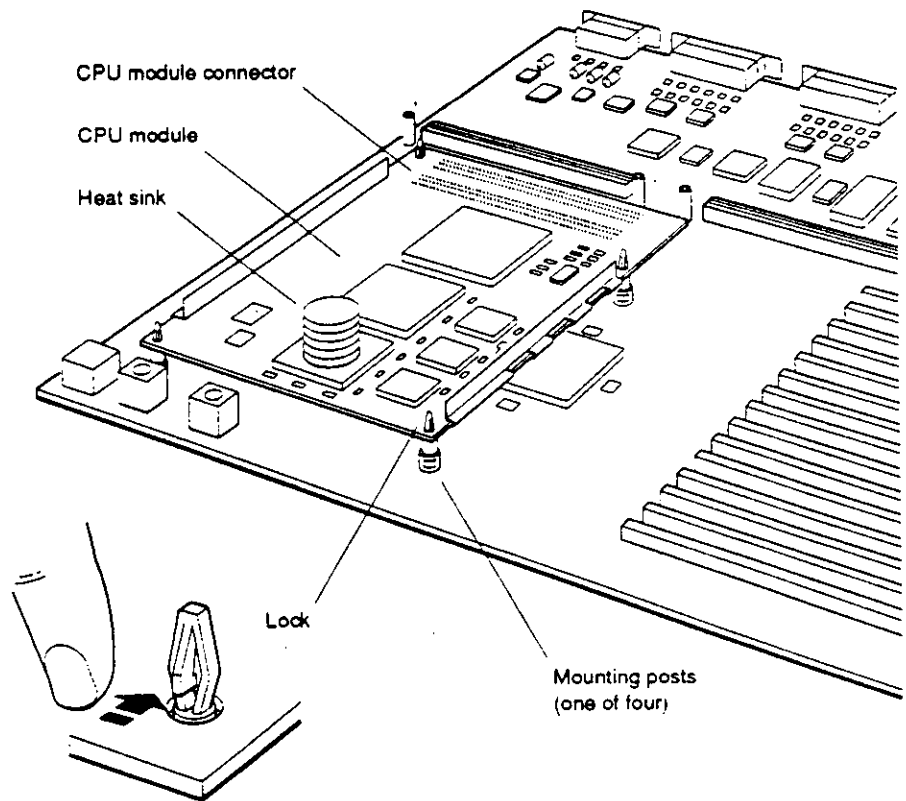

WS3PO062

Figure 9-6. Typical CPU module

8. When the module is free of the mounting post locks, pull the module completely out of the module connector and remove it from the system unit.

**Caution:** Do not pull on the heat sinks, as that can damage the CPU module.

9. Set the CPU module aside carefully. Put it in an antistatic bag, if you have one, or use the bag from the new CPU module after you unpack it.

## To Install a New CPU Module

1. Remove the new CPU module from the antistatic bag.

*Caution: Do not touch the pins in the module connector as this can damage the CPU module.*

2. Align the mounting holes on the CPU module with the mounting posts on the base module in the system unit. Then push the CPU module straight down over the posts and into the CPU connector on the base module.

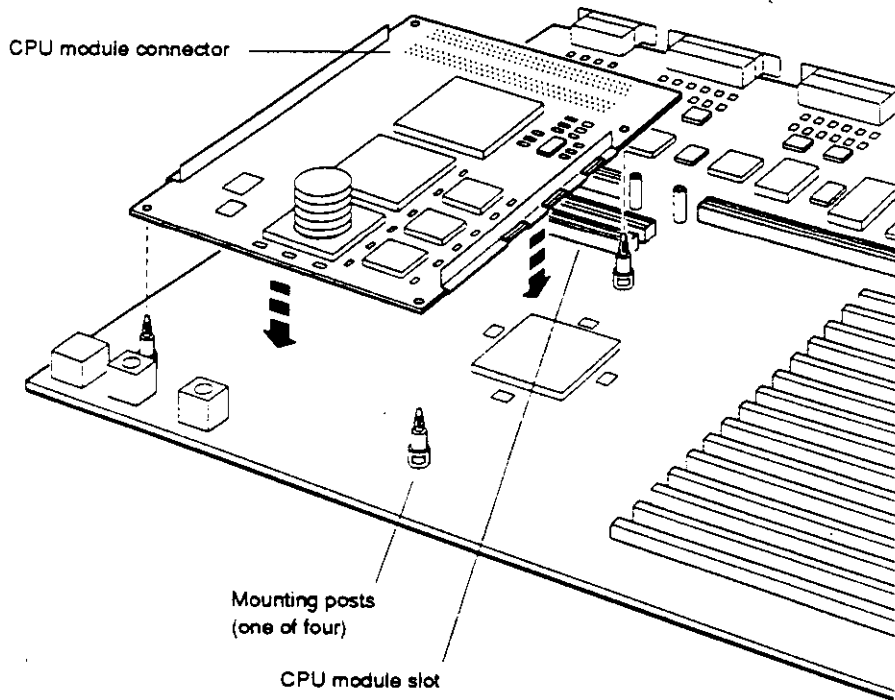

WS3PO063

**Figure 9-7. Installing a CPU module**

3. If you are installing a different model CPU than the one your workstation came with, replace the nameplate medallion on the outside of the system unit cover.
  - a. Turn the system unit cover upside down and remove the nameplate medallion. Squeeze the tabs on the back of the medallion and push them through the holes as shown in Figure 9-8.
  - b. Press the medallion for the new CPU module into the nameplate holes on the front of the cover.

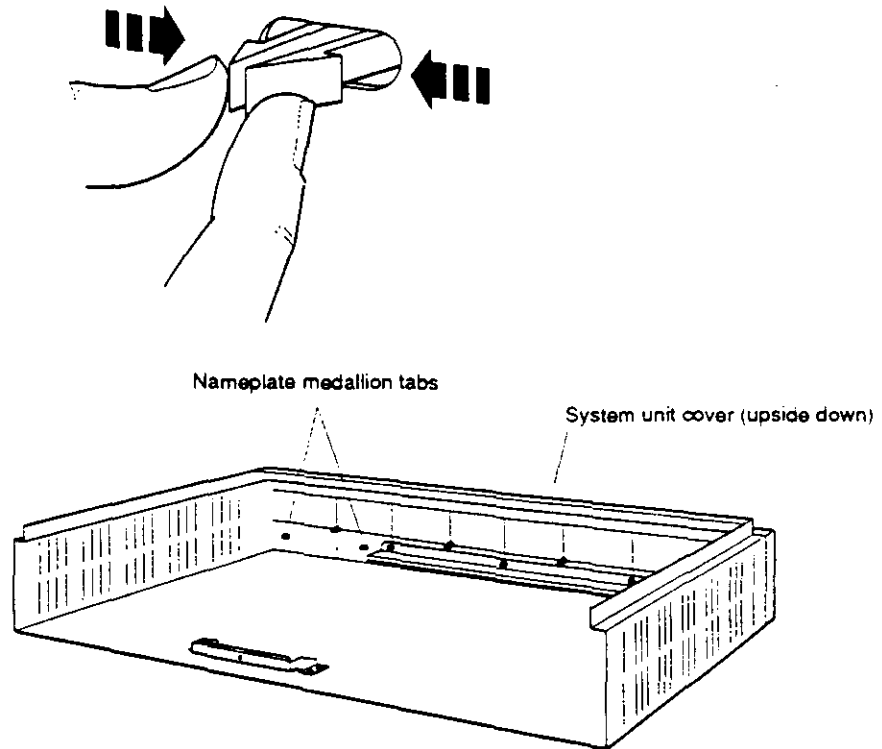

WS3PO004

**Figure 9-8. Removing the nameplate**

4. Replace the cover of the system unit (see "To Replace the Cover on the System Unit" on page 8-7).

## To Test the CPU Module

1. Turn on your workstation.
2. The workstation runs the power-up self test. For details about the self-test, see Chapter 3.
3. When the console prompt (>>) appears, type **t3/misc/cpu-type**.

If the system recognizes the CPU module, it displays the message: 3/misc/cpu-type's code: *type-code*

The *type-code* displayed should match that of the CPU module you installed.

If your workstation fails to recognize the CPU you just installed, try installing the CPU module again. The module connectors may not have been aligned correctly. If the test fails again, call your Digital service representative for help.

## Installing and Removing TURBOchannel Option Modules

Your DECstation 5000 Model 240 workstation comes with three TURBOchannel option slots in which you can install various TURBOchannel option modules. You can install a double- or triple-wide TURBOchannel module in either the system unit or a TCE. For a discussion of TURBOchannel options, refer to "TURBOchannel Option Modules" in Chapter 8.

If you are installing a TURBOchannel module in a TCE, you also need to install a TCE option module in the system unit, which connects to the module in the TCE. Follow these instructions:

1. Remove the cover from the workstation system unit (see "Removing and Replacing the System Unit Cover" on page 8-6 for instructions).
2. Refer to the *TURBOchannel Extender Operator's Guide* for instructions on installing the TURBOchannel module in the TCE and the TCE option module in the system unit.

If you are installing TURBOchannel option modules in the system unit, follow these instructions:

1. Remove the cover on the system unit (see "Removing and Replacing the System Unit Cover" on page 8-6 for instructions).
2. Refer to the chapter in the *TURBOchannel Options User's Guide* that discusses the option you want to install.



# Part IV

---

## Managing Your Workstation

---

## Using the Console Commands

This chapter tells you how to

- Select console and operating modes
- Install a terminal as an alternate system console
- Use the console commands
- Set environment variables

## Console and Operating Modes

Your workstation functions in two modes: console mode and operating mode. When your workstation is in console mode, you are using the setup and testing software that is built into the workstation. You use console mode and the console commands for such tasks as

- Running workstation self-tests
- Displaying workstation hardware configurations
- Setting workstation environment variables
- Booting (starting) the operating system

When your workstation is in operating mode, you are using your worksystem software for such activities as

- Running applications in DECwindows
- Backing up files
- Sending and receiving electronic mail

This manual explains how to use the workstation in console mode. Your worksystem software manuals explain how to use the workstation in operating mode.

## Using Console Mode

The workstation starts in console mode and stays in that mode until you start your worksystem software. While you are in console mode, you can use the console commands, which are the commands of the built-in setup and testing software.

You enter console commands at the system console. If you connected only one monitor to your workstation, that monitor is your system console. If you connected multiple monitors, the monitor in the TURBOchannel option slot with the lowest number is the system console. If you connected a terminal and you have typed **setenv console s**, the terminal is your system console.

## To enter console mode

To enter console mode, do one of the following:

- If you are using ULTRIX worksystem software, type **shutdown -h now** at the ULTRIX prompt and press Return
- Press the halt button on the back of the system unit
- Turn off the power to the system unit and turn it back on again.

*Caution: Turning off the power or pressing the halt button while your workstation and any worksystem software are running may cause the loss or corruption of data.*

## Console prompts

When you use console mode, the workstation displays one of these two prompts on the screen of the system console: >> or R>.

- The >> prompt means that the workstation is in privileged mode. Users can execute all console commands at the console prompt.
- The R> prompt means that the workstation is in restricted mode. The restricted console prompt (R>) indicates that someone has set up a password requirement to restrict access to the console prompt. At the restricted console prompt, you can use only the boot and passwd console commands until you enter the correct password.

To change to the console prompt (>>), type **passwd** and press Return. Then enter the console password and press Return again. If you don't know the password, contact your system manager or a Digital service representative.

## Installing a Terminal as an Alternate System Console

The system console displays error messages and other system messages from the workstation, from networks, and from the worksystem software. You also use the system console to enter console commands, such as the cnfg command.

You generally use your workstation monitor in console mode as the system console. If a monitor is not available, you can use a terminal as an alternate system console. A terminal can display text only; it cannot display illustrations, DECwindows, or DECwindows applications; therefore, you cannot use a terminal as a standard workstation monitor. Some users prefer to connect both a monitor and a terminal to their workstations. In console mode, with both a monitor and a terminal configured, the monitor screen displays graphics tests while the terminal screen displays other tests and text input.

The following instructions explain how to install a terminal and keyboard as a system console.

Contact your Customer Support Center if you have questions about using a terminal.

### To Install a Terminal as a System Console

1. Follow the instructions that came with your worksystem software to shut down the software.
2. Turn off the system unit by pressing the 0 on the on/off switch on the back of the system unit.
3. Plug a communications connector adapter into one of the serial communications connectors on the system unit (communications port 3 is preferred).
4. Find the terminal-to-system-unit cable that came with your terminal. Notice that it has telephone-jack-type connectors on both ends.

Plug one end of the terminal-to-system-unit cable into the communications connector adapter (see Figure 10-1).

5. Plug the other end of the terminal-to-system-unit cable into the modular connector on the back of the terminal.

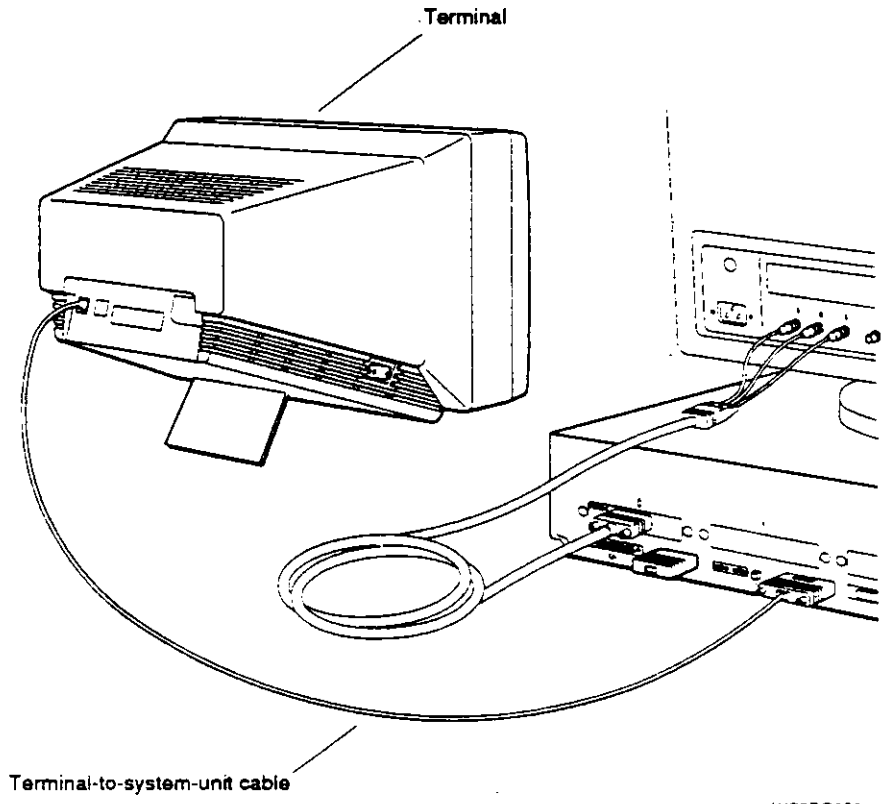

WS3PO056

Figure 10-1. Connecting a VT320 terminal to the system unit

6. Find the coiled keyboard cable that came with your terminal. Notice that it has telephone-jack-type connectors at both ends, and that one end has a keyboard icon.  
Plug the end of the terminal keyboard cable with the keyboard icon into the connector on the side of the terminal.
7. Plug the other end of the terminal keyboard cable into the modular connector on the end of the terminal keyboard.
8. Put a keyboard-mouse port terminator on the system unit keyboard-mouse connector if the connector is not in use (that is, no monitor keyboard cable is attached).
9. Connect a power cord to the terminal and to a power outlet.
10. Turn on the terminal and the system unit and wait for the system self-test to finish before proceeding. The workstation monitor, rather than the terminal, is still acting as the system console at this point.

To activate the terminal as the system console, refer to "To Activate the Terminal as the System Console".

### **To Activate the Terminal as the System Console**

You must set the console environment variable to `s` to make the terminal your system console. The operating system will then be under the control of the terminal each time you boot the system, until you change the console environment variable again.

1. Follow the instructions that came with your worksystem software to shut down the software.
2. To activate the terminal as the system console, type **setenv console s** at the workstation monitor console prompt and press Return.

## To Make Your Workstation Monitor the System Console

The workstation monitor is the system console by default. If you have set the console environment variable to s, your terminal is currently the system console. To make your monitor the system console again,

1. Follow the instructions that came with your worksystem software to shut down the software.
2. Type **setenv console \*** at the console prompt on the terminal and press Return.
3. Turn off the terminal if you are using the monitor as the system console.



## Rules for Typing Console Commands

You can use all console commands when the system monitor displays the console prompt (>>). A restricted console prompt (R>) indicates that someone has set up a password requirement. You can use only the boot and passwd commands at the restricted console prompt until you enter the correct password. Then the normal console prompt (>>) appears.

To use a console command, type the command as shown, add appropriate options and arguments, and press Return.

Follow these rules:

- Type uppercase and lowercase letters exactly as they appear in the manual. The system recognizes the difference between uppercase and lowercase letters.
- Press Return after typing a command.
- Use these handy key combinations:
  - Ctrl-s freezes the screen display.
  - Ctrl-q releases a frozen screen display.
  - Ctrl-c aborts a command.
  - Ctrl-u erases a partially typed command line.
  - DEL erases the last character typed.
- To type a hexadecimal number, precede the number with 0x (zero x). To type an octal number, precede the number with 0 (zero). To type a decimal number, do not precede the number with any leading 0's (zeros).
- To use the Ctrl commands, hold down the Ctrl key while you type the letter of the command. For example, to use Ctrl-s, hold down Ctrl while you type s.

## Conventions Used in This Chapter

- **Letters in boldface type like this** should be typed exactly as they appear.
- *Words in italic type like this OR LIKE THIS* are options or arguments for the commands. You must replace them with the appropriate information. For example, the script command has a *scriptname* argument. When you type the command, you replace *scriptname* with the name of the script you are creating.
- Options are read by the console programs. Arguments are read by the worksystem software.
- When options and arguments are shown in brackets, you should use them only if they are appropriate. When they are not in brackets, you must use them all the time. For example, the `printenv` command is shown like this:

```
printenv [env]
```

Because `[env]` is enclosed in brackets, you should use it only when it is appropriate, which in this case is when you want to display the setting of one environment variable.

The script command is shown like this:

```
script scriptname
```

Because *scriptname* is not shown in brackets, you must use it in every script command.

Do not enclose options and arguments in brackets when you type them. The brackets are just a way of showing you when to use them.

- When an argument is followed by an ellipsis, you can use more than one argument with the command.

## Console Commands

This section explains all of the console commands for workstation users, system managers, service representatives, and other technical specialists.

Table 10-1 lists the console commands.

**Table 10-1. Console Commands**

Command	Function
<b>?</b>	Displays a list of console commands and formats
<b>boot</b>	Boots the system
<b>cat</b>	Displays scripts
<b>cnfg</b>	Displays system configuration information
<b>d</b>	Deposits (that is, writes) data into memory
<b>e</b>	Examines memory contents
<b>erl</b>	Displays a log of error messages
<b>go</b>	Transfers control to a specific address
<b>init</b>	Resets the system
<b>ls</b>	Displays a list of files present in a module ROM
<b>passwd</b>	Sets and clears the console password
<b>printenv</b>	Prints environment variables
<b>restart</b>	Restarts the worksystem software
<b>script</b>	Enters a short script at the console
<b>setenv</b>	Sets environment variables
<b>sh</b>	Starts a script
<b>t</b>	Starts module diagnostic tests
<b>unsetenv</b>	Deletes environment variables

To display the help menu, type a question mark (?) and press Return. The console commands appear in the help menu on the screen as follows:

```
boot [[-z #] [-n] #/path [ARG...]]
cat SCRPT
cnfg [#]
d [-bhw] [-S #] RNG val
e [-bhwcdux] [-S #] RNG
erl [-c]
go [ADR]
init [#] [-m] [ARG...]
ls [#]
passwd [-c] [-s]
printenv [EVN]
restart
script SCRPT
setenv EVN STR
sh [-belvS] [SCRPT] [ARG...]
t [-l] #/STR [ARG...]
unsetenv EVN
```

The following subsections describe the console commands in detail. Note that the command descriptions do not always use the format that appears in the help menu.

?

>>? [command]

The ? command displays the help menu. If you enter the name of a specific command after the ?, the screen displays the help message for that command only.

## boot

```
>>boot [OPTIONS] [#/path]
[argument...]
```

Options are

- a Use a multiuser bootstrap.
- n Load but do not execute *path* program.
- z *number* Wait for *number* seconds, then boot.

The boot command loads and executes the program specified by *#/path*, where # is the slot number of the device that you are booting from, and *path* is the file specification of the program. The -a argument boots for a multiuser environment; to perform a single-user boot, enter the boot command without the -a

argument. The `-n` option suppresses execution of the program after it is loaded. The `-z` option causes the system to wait before booting. When you enter the command with no options, path, or argument, it uses the options, path, and argument in the boot environment variable (see "Environment Variables" on page 10-23.)

The following example of the boot command uses the options and arguments that you set in the boot environment variable:

```
boot
```

The following command boots from a tape drive in base slot 3 (tz is the device code of the drive, and 5 is its SCSI ID number):

```
boot 3/tz5
```

- The following command boots from the network that is connected to your workstation at option slot 2:

```
boot 2/mop
```

The following command performs a multiuser boot (`-a`) using the file `vmunix` on an external drive (`rz1`) in base slot 3 (`rz1` is the device code and SCSI ID for the drive):

```
boot 3/rz1/vmunix -a
```

## cat

```
>>cat #/scriptname
```

The `cat` command displays the contents of the script specified by *scriptname*. The `#` option indicates the number of the slot where the script is stored.

## cnfg

```
>>cnfg [#]
```

The `cnfg` command displays important information about the configuration of your workstation. The information tells you what kind of hardware is in the workstation and connected to it. If you type a slot number for #, the command displays configuration information for that slot. Otherwise, it displays general information for all the slots.

The following example shows the display for a `cnfg` command in which the specific slot number was not specified. This information shows what kind of modules are in the base system slot (base slot 3) and in the option slots. The workstation has option modules in slots 0 and 1, but not in slot 2. The numbers in black circles correspond to the descriptions that follow.

```
>>cnfg
 ① 3:  ② KN03-AA  DEC  X2.0d  TCF0  (224 MB, ③ 1 MB NVRAM)
      (enet: 08-00-2b-0f-45-72)
      (SCSI = 7)
 0:  PMAG-AA  DEC  V5.3d  TCF0  (CX -- D=8)
 1:  PMAD-AA  DEC  V5.3d  TCF0  (enet: 08-00-2b-0f-45-31)
```

- ① Slot number.
- ② Model code. This code indicates the model of the hardware item. For example, `KN03-AA` is the model code of the system module.
- ③ Module code. This code shows what kind of module is installed in the slot.

Slot 3 is the system module slot (often referred to as base slot 3). It always contains the memory (MB) modules, a base system Ethernet (`enet`) controller, and a base system SCSI (`SCSI`) controller. The MB code shows the total amount of memory installed in the workstation (in this case, 224 megabytes). The SCSI code (in this case, 7) is the SCSI ID of the SCSI controller for the slot. The `enet` code is the Ethernet address for the Ethernet controller in that slot.

Table 10-2 lists the module codes that may appear in item 3 of the cnfg display:

**Table 10-2. Module Codes**

Module Code	Description
CX---d=8 or 24	True color frame buffer, where d=8 indicates color or gray scale, and d=24 indicates "true" color (any color the eye can see). This module can be installed in any TURBOchannel option slot.
CXT 8 plane	Smart frame buffer. This module can be installed in any TURBOchannel option slot.
DA: PXG+---D=8 or 24	Low 3D graphics accelerator, where D=8 indicates color or gray scale, and D=24 indicates "true" color (any color the eye can see). This module occupies two adjacent TURBOchannel option slots, but is connected to the system through the lower-numbered slot.
EA: PXG+---D=8 or 24	Mid 3D graphics accelerator, where D=8 indicates color or gray scale, and D=24 indicates "true" color (any color the eye can see). This module occupies two adjacent TURBOchannel option slots, but is connected to the system through the lower-numbered slot.
enet:	Ethernet controller. A ThickWire Ethernet controller is built into the base system. Other Ethernet controllers may be installed in the TURBOchannel option slots. The long number after enet: is a unique Ethernet station address that identifies the controller for the network software.
FA: PXGTurbo+	High 3D graphics accelerator. This module occupies three adjacent TURBOchannel option slots, but is connected to the system through the lower-numbered slot.

(continued on next page)

Table 10-2 (Cont.). Module Codes

Module Code	Description
MB	Memory module. The number indicates the megabytes of memory installed in base slot 3.
MX---D=1	Monochrome frame buffer, where D=1 indicates black and white. This module can be installed in any TURBOchannel option slot.
NVRAM	Nonvolatile random-access memory (RAM) module. An NVRAM module is an optional module that is preinstalled in the base system, if purchased for your workstation. It provides 1 megabyte of battery backed-up memory that will retain data during a power failure.
PX---D=8	2D graphics accelerator, where D=8 indicates color or gray scale. This module can be installed in any TURBOchannel option slot.
SCSI	SCSI controller. One is built into base slot 3; others may be installed in the TURBOchannel option slots.

The next example shows a configuration display for a specified option slot. In this case, it is for the base system slot (slot 3).

The numbers in black circles correspond to the item descriptions in the table that follows. Notice that the first three numbered pieces of information have already been described in the previous example.

The rest of the display provides details regarding the devices and memory that are installed in the base slot (three devices and six memory modules).



3: <sup>1</sup> KN03-AA <sup>2</sup> DEC X2.0d TCF0 <sup>3</sup> (224 MB, 1 MB NVRAM)  
 (enet: 08-00-2b-0f-45-72)  
 (SCSI = 7)

<sup>4</sup> DEV	<sup>5</sup> PID		<sup>6</sup> VID	REV	SCSI DEV
rz2	RZ55	(C) DEC	DEC	0700	DIR
rz4	RX23	(C) DEC	DEC	0700	DIR
tz1					SEQ

dcache ( 64 KB), icache ( 64 KB)

mem( <sup>7</sup> 0): a0000000: a1fffffff ( <sup>8</sup> 32 MB)  
 mem( 1): a2000000: a3fffffff ( 32 MB)  
 mem( 2): a4000000: a5fffffff ( 32 MB)  
 mem( 3): a6000000: a7fffffff ( 32 MB)  
 mem( 4): a8000000: a9fffffff ( 32 MB)  
 mem( 5): aa000000: abfffffff ( 32 MB)  
 mem( 6): ac000000: adfffffff ( 32 MB)  
 mem(14): bc000000: bc0fffffff ( 1 MB) Presto-NVR

<sup>9</sup> mem(14): clean, batt OK, armed

>>

- ① Slot number.
- ② Model code.
- ③ Module code.
- ④ Device code with SCSI ID number of the device. For example, in rz4, the SCSI ID number is 4.
- ⑤ Product ID. Some devices show a product ID in this column, but others do not.
- ⑥ Device descriptor, which provides a general description of the device. DIR indicates direct access drives (diskette and hard disk drives), SEQ indicates sequential access drives (tape drives), and CD-ROM indicates optical compact disc drives.
- ⑦ Memory slot number.
- ⑧ Amount of memory in the slot. The amount can be 8 or 32 megabytes for SIMMs, and 1 megabyte for NVRAM (in memory slot 14 only). All the slots must have the same amount of memory, except for the NVRAM module.
- ⑨ Status of the NVRAM module.

Table 10-3 shows the device codes and device descriptors of SCSI devices, as indicated in items 4 and 6 of the cnfg display.

Table 10-3. SCSI Device Codes and Descriptors

Device Code	Device Descriptor	Type of Drive
rx	DIR	Diskette
rz	CD-ROM	Optical compact disc
rz	DIR	Hard disk
tz	SEQ	Tape

**d**

```
>>d [OPTIONS]  
RANGE value
```

Options can be

**-w** Word (default).  
**-h** Halfword.  
**-b** Byte.  
**-S count** Repeat deposit *count* times.

Ranges can be

*address* Single address.  
*address:address* Start and end address.  
*address#count* Start address and count.  
*range,range* More than one range.

The **d**, or deposit, command writes values to memory. Values can be stored as words, halfwords, or bytes. The default option is word. The command writes the specified *value* through the range of specified addresses. No intervening blanks are allowed in an address range. You can specify the address range as follows:

- A single address (*address*).
- A starting and an ending address (*address:address*).
- A starting address and the number of addresses (*address#count*).

- Multiple address ranges separated by commas (*range,range*).  
Note that no space follows the comma in an address range.

The **-S** option causes a value to be stored repeatedly in memory. The value is stored *count* times at each address in the address range.

**e**

>>**e** [*OPTIONS*] *RANGE*

Options can be

<b>-w</b>	Word (default).
<b>-h</b>	Halfword.
<b>-b</b>	Byte.
<b>-S count</b>	Repeat examine <i>count</i> times.
<b>-x</b>	Display in hexadecimal format.
<b>-o</b>	Display in octal format.
<b>-u</b>	Display in unsigned decimal format.
<b>-d</b>	Display in decimal format.
<b>-c</b>	Display as ASCII characters.

Ranges can be

<i>address</i>	Single address.
<i>address:address</i>	Start and end address.
<i>address#count</i>	Start address and count.
<i>range,range</i>	More than one range.

The **e**, or examine, command examines the contents of memory. Memory can be examined as words, halfwords, or bytes. The default option is word. The **e** command examines values in the range of addresses specified. You can specify the address range in these ways:

- A single address (*address*).
- A starting and an ending address (*address:address*).
- A starting address and the number of addresses (*address#count*).

- Multiple address ranges separated by commas (*range,range*). Note that no intervening space follows the comma in an address range.

You can choose how to display the memory data with format options: `-x`, `-o`, `-u`, `-d`, and `-c`. You can use more than one option, in which case the data is displayed in every format that you choose. If you do not indicate a format, the system displays the data in hexadecimal format.

The `-S` option fetches the contents of each address in the address range *count* times. The screen displays only the final value in each range.

### **erl**

```
>>erl [-c]
```

The `erl` command displays the log of error messages (see Chapter 11). The system records error messages in a special error log buffer, and the `erl` command displays the contents of this buffer. If you specify `-c`, the buffer is cleared. The system stops recording error messages when the buffer is full and resumes when the buffer is cleared.

### **go**

```
>>go [address]
```

The `go` command transfers control of the workstation to the specified address. If you do not specify an address, `go` uses the execution address returned by the last `boot -n` command. If the `boot -n` command has not been executed and no address is specified, the system ignores the `go` command.

### **init**

```
>>init [#] [argument...]
```

The `init` command initializes module hardware. If you specify a slot number (`#`), the command initializes the modules in that slot only.

Arguments are specific to each module.

## ls

```
>>ls [#]
```

The **ls** (list) command displays a list of the files in a module ROM. If you do not specify a slot number (#), the command lists the files for all modules.

## passwd

```
>>passwd [OPTIONS]
```

Options can be

- s**                   Set a new console password.
- c**                   Clear the console password.

- Use the **passwd** command to enter, set, or clear your console password.

The console password keeps unauthorized people from using the console commands on your workstation. You do not need to use the password if security is not an issue in your workplace.

When you first set up your workstation, you do not need a console password. The only way that a console password can be required is if you choose to start using one.<sup>1</sup>

To start using a console password, type **passwd -s** and press Return. The system displays a prompt (**pwd:**) asking you to type the password that you want to use. Type a word with at least six characters. You can use letters and numbers; the system recognizes the difference between uppercase and lowercase letters.

The system displays the **pwd:** prompt twice. Type the same password each time. For the sake of security, the screen does not display what you type, so type something that is easy to remember.

---

<sup>1</sup> The console password is not the same as the passwords required by your worksystem software or networks. The console password protects your workstation hardware by controlling access to the console commands.

Once you choose a password, the system displays a restricted console prompt when you first start your workstation. It looks like this:

R>

At this prompt, you can only boot your worksystem software or enter your console password.

- Boot your worksystem software. Type **boot** and press Return. This is the only boot command that you can use. It has no options or arguments. It uses the values that you set in the boot environment variable (see "Environment Variables" on page 10-23.) If you have not set the variable, the command does not work.
- Enter your console password. Type **passwd** and press Return. Then type your console password at the `pwd:` prompt. For the sake of security, the screen does not display what you type.

After you enter your console password, the prompt changes to the standard console prompt (`>>`). You can now use all the console commands that are described in this chapter.

To stop using your console password, type **passwd -c** at the standard console prompt and press Return. Afterwards, you will have unrestricted access to the console commands.

### **printenv**

```
>>printenv [env]
```

The **printenv** command displays the values of environment variables. If you specify the name of an environment variable, the command displays the value of only that variable. See "Environment Variables" on page 10-24 for more information.

### **restart**

```
>>restart
```

The **restart** command attempts to restart the worksystem software. This command relies on a restart facility that you have to enable in the worksystem software.

## script

```
>>script scriptname
```

The **script** command allows you to write a short temporary script at the system console. A script is a miniprogram. After you write the script, you can run it with the **sh** command, or you can type the name (*scriptname*) of the script by itself at the console prompt to execute the script.

To write a script, type **script** followed by a name for the script and press Return. Then write the script line by line. When you are done, go to a new line and press Return.

## setenv

```
>>setenv env value
```

The **setenv** command sets the value of an environment variable. Note that you must enclose the command in double quotation marks if *value* contains blank spaces. See "Environment Variables" on page 10-24 for more information.

## sh

```
>>sh [OPTIONS] [#!/scriptname]  
[argument...]
```

Options can be

<b>-e</b>	Exit on error.
<b>-b</b>	Branch to script.
<b>-v</b>	Verbose; echo to console.
<b>-S</b>	Suppress script-not-found errors.
<b>-l</b>	Execute in a loop. (This option is the letter "el," not the number one.)

The **sh**, or **shell**, command activates, or runs, a script. Replace # with the slot number of the module that contains the script.

If you specify a script name for the *scriptname* option, the script is used as the input. Otherwise, what you type at the console is the input, and a subshell is created. When you run a shell script, environment variable 0 is set to the script name, 1 is set to the first argument in the script, 2 is set to the second argument, and so on.

The **-e** option directs the shell to exit when an error occurs. Normally, the shell ignores errors. The **-b** option executes the script specified by *scriptname* instead of creating a subshell. The **-v** option causes the script to be echoed to the console when it is executed. The default setting is no echo. The **-S** option suppresses any error message if the script is not found and causes the **sh** command to return a status that indicates success. The **-l** option causes a script to be executed continuously until a system reset occurs or you press Ctrl-c.

**t**

```
>>t [OPTIONS]  #/testname  
[argument...]
```

Options can be

**-l**                   Execute in a loop.

The **t**, or **test**, command runs module tests. Specify a test with *#/testname*, where **#** is the slot number, and *testname* is a module-specific test.

The **-l** option makes the test run continuously until a system reset occurs or you press Ctrl-c.

If the **t** command is part of a script, the system console displays *#/testname* as each test runs.

To display the tests and test formats for a specific module, type **t #/?**, where **#** is the slot number of the module.

Type **test** to run the script that performs a thorough test of the entire system. Typing **test** is a shorthand way of typing **sh 3/test**. If you type **sh -l 3/test**, the test runs continuously.

**unsetenv**

```
>>unsetenv env
```

The **unsetenv** command deletes the value of an environment variable. See "Environment Variables" for more information.



## Environment Variables

Environment variables store system parameters and scripts and pass information to the operating system. Some environment variables stay in memory, but others are lost when you turn off the power.

Table 10-4 summarizes the console commands for setting environment variables. Table 10-5 lists the standard environment variables that you can set.

**Table 10-4. Console Commands for Environment Variables**

Command	Description
<code>printenv</code>	Displays the value of environment variables
<code>setenv</code>	Sets the value of an environment variable
<code>unsetenv</code>	Deletes the value of an environment variable

**Table 10-5. Environment Variables Set by the User**

<code>boot</code> <sup>1</sup>	Specifies arguments for the boot command (see page 10-24).
<code>console</code> <sup>1</sup>	<p>Chooses the system console. You normally do not set this variable. Any setting except <code>s</code>, including the default "blank" setting, selects autoconfiguration and makes your monitor and monitor keyboard the system console. Autoconfiguration makes the monitor in the lowest-numbered option slot the system console. If the workstation has no monitor connected to a graphics module, communications connector 3 becomes the system console slot.</p> <p>To activate a terminal as an alternate system console, set <code>console</code> to <code>s</code>. Chapter 7 explains how to install the terminal. Set <code>console</code> to <code>*</code> to make your graphics monitor the system console again.</p> <p>To display the language menu on the system console, set <code>console</code> to zero.</p> <p>If more than one monitor is connected to the system unit, the monitor in the lowest-numbered slot is the system console.</p>

<sup>1</sup>These environment variables stay in memory until you delete them.

(continued on next page)

**Table 10-5 (Cont.). Environment Variables Set by the User**

---

<b>haltaction</b> <sup>1</sup>	Specifies what happens when you press the halt button or turn on the power: <ul style="list-style-type: none"><li>b Boots the worksystem software, as specified by the boot environment variable.</li><li>h Halts the worksystem software and displays the console prompt.</li><li>r Restarts the worksystem software. If the restart fails, boots the software.</li></ul>
<b>more</b>	Specifies the greatest number of lines of text that can fit on the screen at one time. When text scrolls on the screen, the system stops the scrolling at the number of lines that you set. If you set the number to zero, the text scrolls continuously.
<b>testaction</b> <sup>1</sup>	Controls the power-up self-test: <ul style="list-style-type: none"><li>t Specifies a thorough (but slow) testing of the system.</li><li>q Specifies a quicker but less thorough test.</li><li>m Specifies manufacturing tests. You should not use this setting.</li></ul>
<b>#</b>	The number of the module that contains the current script. If no script is active, the system module is assumed.

---

<sup>1</sup>These environment variables stay in memory until you delete them.

---

There are other environmental variables. Some, like `oconsole`, should not be changed. Others can be set as implementation-specific side effects of various bootstrap and test procedures.

---

## Troubleshooting

This chapter explains

- What kind of information your Customer Support Center needs when you ask for help
- How to be sure all components of your workstation are functioning
- How to use the system self-tests to diagnose common problems new users often have
- How to diagnose and solve other problems

## Where to Look for Which Problem

- If some part of your workstation fails to turn on, refer to the section "Is It On?" beginning on page 11-4.
- If the workstation turns on, but a component doesn't function properly, look in the section "Is It Connected Properly?" beginning on page 11-9.
- If the workstation turns on and everything is connected, but the workstation still doesn't function properly, look in the section "Is It Working?" beginning on page 11-18.

## Contacting Your Customer Support Center

If you follow the recommendations in this chapter and your problem is still not fixed, call your Customer Support Center.

The service representative in the center will ask you these questions:

- What kind of workstation do you have?
  - What is its serial number?
  - How much memory does it have?
  - What kind of monitor is connected to it?
  - What internal drives does it have?
  - What external storage devices and other options does it have?
- What is wrong?
- What error messages were displayed?
- What was the on/off pattern of lights in the diagnostic LED display?
- Did you try to fix the problem yourself? If so, what did you do?

The service representative will try to help you fix the problem while you are on the telephone, so make your call from a telephone near the workstation.

## Is It On?

An indicator light on each hardware component of your workstation shows whether the unit has power or not. In addition, eight small, red diagnostic LED lights on the back of the system unit indicate whether or not the basic components of the workstation are ready to use.

If the workstation is not functioning and no error messages appear on the monitor, check the power indicator lights and the diagnostic LED display. The on/off pattern of the LED display indicates which portion of the power-up self-test failed.

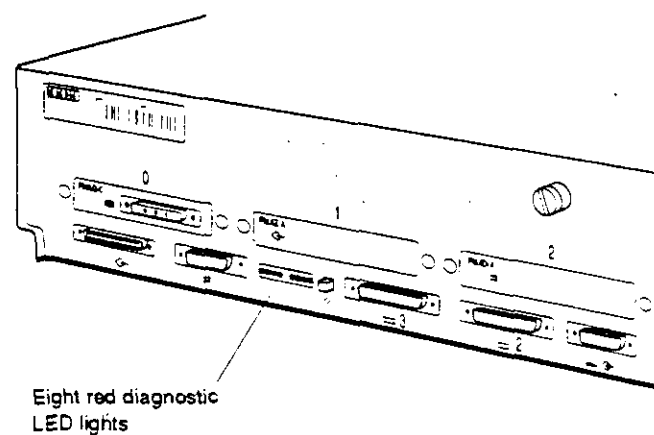
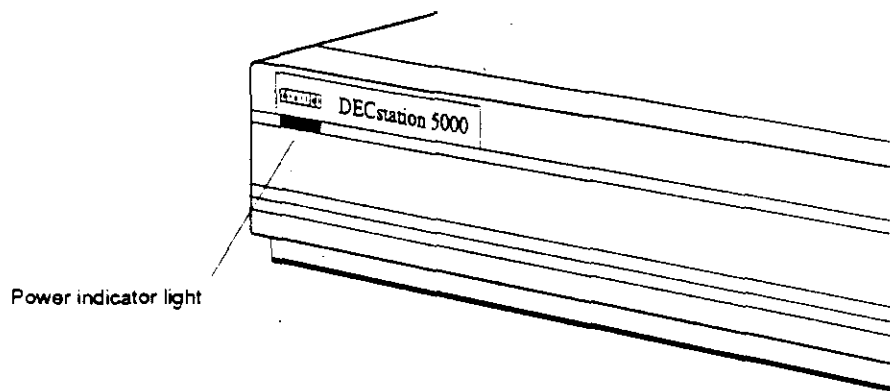

WS3PO060

**Figure 11-1. Indicator light and LED display**

Table 11-1 shows you how to interpret the LED display codes. The codes are shown in the order in which the tests run, so you can determine which subtests ran successfully and at what point the test failed.

If the LED display indicates a problem with your workstation, try the suggestion provided for that LED code in Table 11-1. If no specific suggestion is given, or if the suggested procedure does not solve the problem, try reinstalling the CPU module and the memory modules on the base system module. Then restart the workstation. If the problem still exists, call your system manager or the Digital Customer Support Center.

**Table 11-1. Interpreting the LED Codes**

LED Code	Meaning
••••	Workstation hardware initialization could not begin.
◦◦◦◦	Workstation firmware initialization could not be completed.
◦◦◦◦	Firmware could not initialize the input-output subsystem on the system module to a known state. The input-output subsystem controls the Ethernet and SCSI interfaces, as well as the keyboard, mouse, and other serial-line communications.
◦◦◦◦	Memory slot 0 could not be initialized. Try replacing the memory module in memory slot 0 (see Chapter 9 for instructions).
◦◦◦◦	Firmware could not calculate the cache size. Try reinstalling the CPU module (see Chapter 9 for instructions).
◦◦◦◦	Firmware could not calibrate the millisecond delay loop. Try reinstalling the CPU module (see Chapter 9 for instructions).
◦◦◦◦	Firmware could not configure the system. Try reinstalling the CPU module and all memory modules (see Chapter 9 for instructions).

**Explanation:**

- Light is off.
- Light is on.

(continued on next page)



Table 11-1 (Cont.). Interpreting the LED Codes

LED Code	Meaning
○○○○ ○○○○	<i>If the workstation turns on, all workstation components have been initialized, and the workstation is ready for use. If the workstation does not turn on, a device or module is not connected properly or is broken. Make sure all cables are securely attached and that all external components of the workstation have been installed properly and are plugged into a power source.</i>
○○○○ ●●●● ○○○○ ●●●● ○○○○ ●●●● ○○○○ ●●●●	The system console programs not be initialized. The lights on the left show the slot number of the module with the problem, from slot number 0 (Off Off Off Off) to slot number 3 (Off Off On On). Try reinstalling the option module in the slot indicated by the LED code. If the problem is in the base slot (slot 3), try reinstalling the CPU module and all memory modules (see Chapter 9 for instructions).
○○○○ ○○○○ ○○○○ ○○○○ ○○○○ ○○○○ ○○○○ ○○○○	A read-only memory (ROM) object could not be loaded. This could be a portion of the system module, system firmware, or firmware for an option module. The lights on the left show the slot number of the module with the problem, from slot number 0 (Off Off Off Off) to slot number 3 (Off Off On On). Try reinstalling the option module in the slot indicated by the LED code. If the problem is in the base slot (slot 3), try reinstalling the CPU module and all memory modules (see Chapter 9 for instructions).
○○○○ ○○○○ ○○○○ ○○○○ ○○○○ ○○○○ ○○○○ ○○○○	The workstation was initialized, but there is a problem in the system module or one of the option modules. The lights on the left show the slot number of the module with the problem, from slot number 0 (Off Off Off Off) to slot number 3 (Off Off On On). Type <code>erl</code> at the console prompt <code>&gt;&gt;</code> to display any error messages relating to the problem. Then turn to the section "How to Interpret Self-Test Messages" on page 11-19 and look up the error message.

Explanation:

- Light is off.
- Light is on.

(continued on next page)

**Table 11-1 (Cont.). Interpreting the LED Codes**

---

LED Code	Meaning
○○○○ ○○○● ○○○● ○○○● ○○●○ ○○○● ○○●● ○○○●	The worksystem software could not be loaded. The lights on the left show the slot number of the module where the software is stored, from slot number 0 (Off Off Off Off) to slot number 3 (Off Off On On). Check to make sure that the device on which the software is stored has power, is properly connected to the system unit, and has a unique SCSI ID (see Chapter 5 for instructions). If the problem persists, try reinstalling the SCSI controller module in the slot indicated by the LED code. If the problem is in the base slot (slot 3), try reinstalling the CPU module and all memory modules (see Chapter 9 for instructions).

---

**Explanation:**

- Light is off.
  - Light is on.
-

## Is It Connected Properly?

Table 11-2 lists some problems that new users may have, and some problems that may occur after new hardware has been installed. Many of these problems can be solved easily by following the suggestions in the table. If these solutions do not resolve the problem, see "Is It Working?" on page 11-18.

Table 11-2. Solutions to Common Problems

Problem	Solution
Amount of memory in the cnfg 3 display is incorrect.	<ol style="list-style-type: none"><li>1. Note the slot location and size of each memory module listed in the cnfg 3 display and compare it to the actual memory module in the specified system unit memory slot. Reinstall any memory modules that do not appear in the display (see Chapter 9 for instructions).</li><li>2. If the problem persists, type <code>t 3/mem *</code> at the console prompt and see "How to Interpret Self-Test Messages" on page 11-19 to interpret the test results.</li></ol>
The NVRAM module you ordered does not appear in the cnfg 3 display.	<ol style="list-style-type: none"><li>1. Turn off your workstation.</li><li>2. Check to make sure the NVRAM module is installed in memory slot 14.</li><li>3. Reinstall the NVRAM module (see Chapter 9 for instructions).</li><li>4. Turn on your workstation and try the cnfg 3 command again.</li></ol>
The status of the NVRAM module in the cnfg 3 display is anything other than clean, batt OK, armed.	See the NVRAM chapter in the <i>TURBOchannel Options User's Guide</i> for an explanation and instructions.

(continued on next page)

Table 11-2 (Cont.). Solutions to Common Problems

Problem	Solution
A TURBOchannel module for your workstation does not appear in the cnfg display.	<ol style="list-style-type: none"><li data-bbox="560 270 1337 418">1. If the missing module is a TCE option module, check to see if the option module in the TCE (to which it is connected) is displayed. The cnfg display only lists the module in the TCE—not the TCE option module in the system unit.</li><li data-bbox="560 435 1337 496">2. Check to make sure you specified the correct slot number for the missing module in the cnfg command.</li><li data-bbox="560 513 1337 574">3. Reinstall the missing option module (see Chapter 9 for instructions).</li></ol>
An external drive does not appear in the cnfg display	<ol style="list-style-type: none"><li data-bbox="560 666 1344 727">1. Check to make sure you specified the correct slot number for the missing drive in the cnfg command.</li><li data-bbox="560 744 928 769">2. Turn off the workstation.</li><li data-bbox="560 786 1344 873">3. Make sure the external device in which the missing drive is located is turned on and is connected to an active power source.</li><li data-bbox="560 890 1344 977">4. Make sure the external device in which the drive is installed is properly connected to your workstation (see Chapter 5 for instructions).</li><li data-bbox="560 994 1344 1055">5. Make sure the missing drive has a unique SCSI ID from 0 to 6 (see Chapter 5 for instructions).</li><li data-bbox="560 1072 1344 1194">6. If the missing drive is in a TCE or BA42 expansion box, reinstall the drive inside the box (see the <i>BA42 Installation Guide</i> or <i>TURBOchannel Extender Operator's Guide</i> for instructions).</li><li data-bbox="560 1211 1344 1267">7. Turn on your workstation and try the cnfg command again.</li></ol>

(continued on next page)

Table 11-2 (Cont.). Solutions to Common Problems

Problem	Solution
The screen is blank.	<ol style="list-style-type: none"><li>1. Press any key on your keyboard. If your screen saver was active, the display will reappear.</li><li>2. Make sure the system unit and monitor are turned on.</li><li>3. Adjust the brightness and contrast controls.</li><li>4. Turn off the system unit and monitor.</li><li>5. Make sure the system unit power cord and the monitor-to-system-unit power cable or the monitor power cord are connected correctly.</li><li>6. Make sure the video cable is securely connected to the monitor and system unit.</li><li>7. Make sure that your monitor is compatible with the graphics module you are using (see the chapter in the <i>TURBOchannel Options User's Guide</i> that discusses the graphics module or monitor you are using).</li><li>8. Turn on the system unit and monitor.</li></ol>
The screen display is distorted or unstable.	<ol style="list-style-type: none"><li>1. Shut down your worksystem software, if necessary, and turn off the system unit and monitor.</li><li>2. Make sure the video cable connectors are correctly attached to the monitor and system unit.</li><li>3. Make sure that your monitor is compatible with the graphics module you are using (see the chapter in the <i>TURBOchannel Options User's Guide</i> that discusses the graphics module or monitor you are using).</li><li>4. Turn on the system unit and monitor.</li></ol>

(continued on next page)

Table 11-2 (Cont.). Solutions to Common Problems

Problem	Solution
Color is distorted or unclear.	<ol style="list-style-type: none"><li data-bbox="509 260 1324 355">1. Move such items as magnetic paper clip holders and electric pencil sharpeners or other electromechanical devices away from the monitor.</li><li data-bbox="509 364 1324 460">2. If your monitor has a degauss button, press it for 5 seconds. If the monitor has no degauss button, turn the monitor off and then on again.</li><li data-bbox="509 468 1324 538">3. See the manuals for your monitor for further troubleshooting instructions.</li></ol>
Red or blue is missing from the display on your color monitor.	<ol style="list-style-type: none"><li data-bbox="509 624 1324 685">1. Shut down your worksystem software and turn off the system unit and monitor.</li><li data-bbox="509 703 1324 789">2. Make sure the video cable connectors are attached to the monitor correctly. Chapter 1 explains how to connect monitors.</li><li data-bbox="509 807 1324 841">3. Turn on the system unit and monitor.</li></ol>
The DIGITAL logo is red instead of blue on the login screen on your color monitor.	<ol style="list-style-type: none"><li data-bbox="509 928 1324 989">1. Shut down your worksystem software and turn off the system unit and monitor.</li><li data-bbox="509 1006 1324 1067">2. Remove the video cable connector from the video connector on the system unit.</li><li data-bbox="509 1085 1324 1171">3. Unplug the cable connector. Holding the cable connector so the widest part of the connector is on top, reattach the cable connector to the system unit.</li><li data-bbox="509 1189 1324 1218">4. Turn on the system unit and monitor.</li></ol>

(continued on next page)

**Table 11-2 (Cont.). Solutions to Common Problems**

<b>Problem</b>	<b>Solution</b>
Nothing happens on the screen when you type.	<ol style="list-style-type: none"><li>1. Check the Hold Screen indicator light on the keyboard. If the light glows green, press the Hold Screen key.</li><li>2. Shut down your worksystem software, if necessary, and turn off the system unit.</li><li>3. Disconnect the keyboard cable from its connector on the keyboard-mouse connector block and then reconnect it.</li><li>4. Make sure the keyboard-mouse cable is firmly attached to the system unit and turn on the system unit.</li><li>5. Turn off the system unit and monitor, connect another keyboard, and turn on the system unit and monitor again.</li></ol>
You cannot connect to your networks, and you know the worksystem and network software are functioning.	<ol style="list-style-type: none"><li>1. Shut down your worksystem software and turn off the system unit.</li><li>2. Make sure the Ethernet connectors on the system unit are attached correctly (see Chapter 6). If you are using adapters to connect ThinWire or twisted-pair Ethernet cable to your workstation, check those connectors, too.</li><li>3. Turn on the system unit.</li></ol>

(continued on next page)

Table 11-2 (Cont.). Solutions to Common Problems

Problem	Solution
No cursor appears on the screen	<ol style="list-style-type: none"><li data-bbox="520 270 1314 331">1. Check the Hold Screen indicator light on the keyboard. If the light glows green, press the Hold Screen key.</li><li data-bbox="520 348 1314 439">2. Move the mouse around on your desktop, or move the puck or stylus around on your tablet, to see if you accidentally moved the cursor off the screen.</li><li data-bbox="520 456 1314 517">3. Shut down your worksystem software and turn off the system unit.</li><li data-bbox="520 534 1314 624">4. Make sure the mouse cable is correctly connected to the keyboard-mouse connector blocks, and the keyboard-mouse cable is correctly connected to the system unit.</li><li data-bbox="520 642 1314 668">5. Turn on the system unit.</li><li data-bbox="520 685 1314 718">6. If the problem is not fixed, install another mouse or tablet.</li></ol>
The cursor on the screen fails to follow the movement of your pointing device (mouse, puck, or stylus).	<ol style="list-style-type: none"><li data-bbox="520 808 1314 869">1. Shut down your worksystem software and turn off the system unit.</li><li data-bbox="520 887 1314 977">2. Make sure the cable for the device is connected securely to the keyboard-mouse connector block and to the device itself.</li><li data-bbox="520 994 1314 1020">3. Turn on the system unit.</li><li data-bbox="520 1038 1314 1067">4. If the problem is not fixed, install another pointing device.</li></ol>

(continued on next page)



Table 11-2 (Cont.). Solutions to Common Problems

Problem	Solution
You cannot install worksystem software from an external storage device.	<p><i>If you have only one external storage device,</i></p> <ol style="list-style-type: none"><li>1. Make sure the device is turned on and the power outlet it is plugged into has power.</li><li>2. Use the <code>cnfg</code> command to determine whether the workstation lists the device.</li><li>3. If the device is missing from the display, turn off the device and the system unit and check the following:<ul style="list-style-type: none"><li>■ Make sure the SCSI expansion cable is correctly connected to the device and to the system unit.</li><li>■ Make sure a terminator is correctly attached to the second SCSI connector on the device (unless the device is a TCE, which has an internal SCSI terminator).</li><li>■ Check the SCSI ID switch settings or SCSI ID display window on the device to make sure the SCSI ID is within the range 0 to 6. If not, change the SCSI ID accordingly. See Chapter 5 for instructions on checking and changing the SCSI ID.</li></ul></li><li>4. Turn on the device and the system unit.</li></ol> <p>If the problem still exists, refer to the manual that came with the device and to the installation guide for your workstation software.</p>

(continued on next page)

Table 11-2 (Cont.). Solutions to Common Problems

Problem	Solution
	<p><i>If you have more than one external storage device,</i></p> <ol style="list-style-type: none"><li>1. Make sure all the devices are turned on and the power outlets they are plugged into are active.</li><li>2. Type <b>cnfg</b> and the number of the slot in which the device is connected.</li></ol> <p>If the device does not appear in the configuration display on the screen, turn off all devices connected to the system unit and then turn off the system unit. Then check the following:</p> <ul style="list-style-type: none"><li>■ Make sure the SCSI cables are connected to all the devices in the chain and to the system unit. The SCSI cables between devices should be 18-inch Digital cables.</li><li>■ Make sure a terminator is correctly attached to the second SCSI connector on the last device in the chain (unless the device is a TCE, which has an internal SCSI terminator).</li><li>■ Check the SCSI ID switch settings or SCSI ID display window on all devices in the chain to make sure the SCSI ID of the missing device is unique and is within the range 0 to 6. If not, change the SCSI ID accordingly. See Chapter 5 for instructions on checking and changing the SCSI ID.</li></ul> <ol style="list-style-type: none"><li>3. Make sure you have attached no more than three expansion boxes to a single SCSI connector. If you have attached more than this, you may have exceeded the total allowable cable length for a single SCSI connector (236 inches,) or 6 meters, for all SCSI cabling. Table 5-1 in Chapter 5 provides a table with SCSI cable lengths for each expansion box and explains how to calculate the total cable length for a group of expansion boxes.</li><li>4. Turn on the system unit and the devices.</li></ol> <p>If the problem still exists, refer to the manual that came with the missing device and to the installation guide for your workstation software.</p>

(continued on next page)

**Table 11-2 (Cont.). Solutions to Common Problems**

<b>Problem</b>	<b>Solution</b>
A red light blinks rapidly on the front of your TK50Z tape drive.	<ol style="list-style-type: none"><li>1. Push the load/unload button four times.</li><li>2. Turn the tape drive off and on once.</li></ol>
Nothing happens when you try to use your printer.	<ol style="list-style-type: none"><li>1. Make sure the printer is turned on.</li><li>2. Check your worksystem and communications software to be sure that the device is installed and enabled properly.</li><li>3. Check your system software to be sure the printer is installed in the software.</li><li>4. Shut down your worksystem software, if necessary, and turn off the printer and the system unit.</li><li>5. Make sure the printer power cord is connected to a live power source.</li><li>6. Make sure the printer cable connector is correctly attached to one of the communications connectors on the system unit.</li><li>7. Turn on the system unit and the printer.</li></ol> <p>If the problem is not fixed, see the manuals for your printer.</p>

(continued on next page)

Table 11-2 (Cont.). Solutions to Common Problems

Problem	Solution
Nothing happens when you try to use a communications device.	<ol style="list-style-type: none"><li>1. Make sure the device is turned on.</li><li>2. Shut down your worksystem software, if necessary, and turn off the device and the system unit.</li><li>3. Make sure the device power cord is connected to an active power source.</li><li>4. Make sure the connector on the communications device cable is correctly attached to the communications connector or the communications connector adapter on the system unit.</li><li>5. Make sure the right type of cable is connected to the device. Check the guide that came with the device to determine the proper cables.</li><li>6. Turn on the system unit and the device.</li></ol> <p>If the problem is not fixed, see the manuals for the device.</p>

## Is It Working?

If your workstation components have power and all components seem to be properly connected, but the workstation still does not function properly, try running a full system self-test. To do this, you must first shut down your ULTRIX worksystem software by typing **shutdown -h now** at the ULTRIX prompt and pressing Return. Then, at the console prompt (>>), type **test** and press Return.

For more complete instructions on how run a self-test, see "Testing Your Workstation" on page 3-6.

## How to Interpret Self-Test Messages

Self-tests display error messages when they discover problems in the hardware. The number after ?TFL: is the slot number of the module that has a problem.

- If 0, 1, or 2 follows ?TFL:, the problem is in the TURBOchannel option slot that has the same number. For troubleshooting instructions, see the *TURBOchannel Options User's Guide* chapter that discusses the TURBOchannel module installed in that slot.
- If 3 follows ?TFL:, the problem is in the base system hardware. Copy the messages and then look for them in Table 11-3. This table explains how you can probably fix the problem. If you cannot fix it, call the Digital Customer Support Center.



**Table 11-3 (Cont.). Self-Test Error Messages for the Base System Slot**

mem	<p>Random-access memory (RAM) is faulty. Make sure that all the memory modules are firmly seated in their connectors in the system unit and then run the memory test. Type <code>t 3/mem *</code> and press Return. The memory test checks every memory module, taking several minutes for each one. If it finds a problem, it displays a message with one of the following formats, where <i>slot-num</i> indicates where the faulty memory module is installed.</p> <p>?TFL: 3/mem (1:board <i>slot-number</i>, MBE= <i>number</i>, SBE= <i>number</i>)</p> <p>?TFL: 3/mem (2:board <i>slot-number</i>, too many SBES: <i>number</i>)</p> <p>Remove or replace the faulty memory module (see Chapter 9 for instructions). You must retain at least 16 megabytes of memory for your workstation to operate correctly. After removing or replacing all faulty memory modules, run the memory test again. If the test still reports a problem, copy the entire message and call your system manager or Customer Support Center.</p>
mem/float10, mem/init, mem/select	<p>A memory module is faulty. If one of these error messages appears, copy the entire message and call your system manager or Customer Support Center.</p>
misc/halt	<p>The halt button or the built-in halt program is faulty. Copy the entire message and call your system manager or Customer Support Center.</p>
misc/kbd	<p>The keyboard, keyboard cable, or connectors are faulty. Make sure that the cable is connected properly (see Chapter 1). Then turn the system unit off and on. If the test message appears again, try replacing first the keyboard cable and then the keyboard. If the message still appears, copy the entire message and call your system manager or Customer Support Center.</p>
misc/mouse	<p>The mouse, mouse cable, or connector is faulty. Make sure that the cable is connected properly (see Chapter 1). Then turn the system unit off and on again. If the test message appears again, replace the mouse. If the message still appears, copy the entire message and call your system manager or Customer Support Center.</p>

(continued on next page)

**Table 11-3 (Cont.). Self-Test Error Messages for the Base System Slot**

misc/pstemp	The flow of air through the system unit is inadequate, or the temperature in your office is more than 104°F (40°C). Make sure there is a space of at least 4 inches (10 cm) between the vents in the system unit cover and other items on your work table. Then turn the system unit off, wait a moment, and turn it on. If a misc/pstemp error message appears again, turn off the system unit, copy the entire message, and call your system manager or Customer Support Center.
misc/wbpart	The CPU module or system memory is faulty. Copy the entire message and call your system manager or Customer Support Center.
ni/llsn ni/common ni/crc ni/ctrs ni/dma1 ni/dma2 ni/int ni/int-lb ni/m-cst ni/promisc ni/regs ni/setup	The Ethernet controller in the base system slot is faulty. If your workstation is connected to a network, disconnect from the network, attach a loopback connector, and retry the test. If the message reappears, copy the entire message and call your system manager or Customer Support Center.
ni/esar	The base system Ethernet address chip is faulty. Copy the entire message and call your system manager or Customer Support Center.
ni/ext-lb	The built-in Ethernet connector in the base system slot or the loopback connector attached to the Ethernet connector is faulty. Replace the loopback connector, if there is one, or make sure that the network cable is connected properly (see Chapter 6). If the test message appears again, copy the entire message and call your system manager or Customer Support Center.
prcache	The NVRAM module is faulty. Reinstall the NVRAM module (see Chapter 9 for instructions). If the message reappears, copy the entire message and call your system manager or Customer Support Center.
rtc/nvr rtc/period trc/regs rtc/time	Interrupt handling or timekeeping in the system module is faulty. Copy the entire message and call your system manager or Customer Support Center.
scc/access scc/dma	The controller for a communications connector is faulty. Copy the entire message and call your system manager or Customer Support Center.

(continued on next page)



**Table 11-3 (Cont.). Self-Test Error Messages for the Base System Slot**

scc/int	The controller for a communications device fails to interrupt the communications signals when appropriate. If the scc/int error message appears, copy the entire message and call your system manager or Customer Support Center.
scc/io	The controller for one of the communications connectors, the connector itself, or a cable attached to the connector is faulty. Make sure that the cables to all your communications devices are plugged in. Then turn the system unit off and on. If the message appears again, copy the entire message and call your system manager or Customer Support Center.
scc/pins	One of the communications connectors is faulty. If an scc/pins test error message appears, copy the entire message and call your system manager or Customer Support Center.
scc/tx-rx	The controller for one of the communications connectors, the connector itself, or a cable attached to the connector is faulty. Make sure that the cables to all your communications devices are plugged in. Then turn the system unit off and on. If the message appears again, copy the entire message and call your system manager or Customer Support Center.
scsi/cntl	The controller for the base system SCSI connector is faulty. Turn the system unit off and on. If the test message appears again, copy the entire message and call your system manager or Customer Support Center. Note that you can still use the SCSI connectors in the option slots.
scsi/sdiag	A SCSI device connected to the base system SCSI controller is faulty, or one of the SCSI cables that is connected to a device in that slot is faulty. Make sure that all SCSI cables are plugged in securely. If you connected a chain of external devices to the slot, make sure that the last device has a SCSI terminator in the unused SCSI connector. Then turn the system unit off and on. If the test message appears again, copy the entire message and call your system manager or Customer Support Center. Note that you can still use the SCSI connectors in the option slots.

(continued on next page)

**Table 11-3 (Cont.). Self-Test Error Messages for the Base System Slot**

---

scsi/target	One of the devices connected to the base system SCSI controller is not reading or writing data properly.  Make sure that all SCSI cables are plugged in securely. If you connected a chain of external devices to the slot, make sure that the last device has a SCSI terminator in the unused SCSI connector. Then turn the system unit off and on. If the test message appears again, copy the entire message and call your system manager or Customer Support Center. Note that you can still use the SCSI connectors in the option slots.
tlb/prb tlb/reg	The CPU module is faulty. Copy the entire message and call your system manager or Customer Support Center.

---

# Part V

---

## Appendixes

# A

---

## Equipment Specifications

This appendix lists the physical specifications, operating conditions, and nonoperating conditions for the following items:

- DECstation 5000 Model 240 system unit
- LK401-AA keyboard
- LK421-AA keyboard
- VSXXX-GA mouse
- VSXXX-AB tablet
- BA42 expansion box
- RZ55 hard disk drive
- RZ56 hard disk drive
- RZ57 hard disk drive
- RZ58 hard disk drive
- TK50Z tape drive
- TZ30 tape drive
- TZK10 QIC tape drive
- TLZ04 cassette tape drive
- RRD42 optical compact disc drive
- RX23 diskette drive
- RX33 diskette drive

# DECstation 5000 Model 240 System Unit Equipment Specifications

**Table A-1. System Unit Description**

Weight	12.70 to 22.70 kg (28.00 to 50.00 lb)
Height	9.14 cm (3.60 in)
Width	51.03 cm (20.09 in)
Depth	43.48 cm (17.12 in)
Input voltage	Auto adjust 100–120 Vac or 220–240 Vac
Input current	5 A at 100–120 Vac 2.4 A at 220–240 Vac
Power	
– Frequency	50 to 60 Hz
– Heat dissipation	359 watts, maximum

**Table A-2. System Unit Operating Conditions**

Temperature range <sup>1</sup>	10°C to 40°C (50°F to 104°F)
Temperature change rate	11°C (52°F) per hour, maximum
Relative humidity	20% to 80%, noncondensing
Maximum wet-bulb temperature	28°C (82°F)
Minimum dew-point temperature	2°C (36°F)
Altitude	2,400 m (8,000 ft) maximum

<sup>1</sup>Reduce maximum temperature by 1.8°C for each 1,000 meter (1.0°F for each 1,000 ft) increase in altitude.

**Table A-3. System Unit Nonoperating Conditions**

Temperature range	–40°C to 66°C (–40°F to 151°F)
Relative humidity	10% to 95%, noncondensing
Maximum wet-bulb temperature	46°C (115°F), packaged
Altitude	4,900 m (16,000 ft) maximum

## LK401-AA Keyboard Equipment Specifications

**Table A-4. LK401-AA Keyboard Description**

---

Weight	1.16 kg (2.56 lb)
Height	4.76 cm (1.88 in)
Width	47.80 cm (19.00 in)
Depth	19.20 cm (7.56 in)
Number of keys	108
Number of indicators	2 status LEDs
Language variations	15 Software selectable (keycaps required)
Cable	1.8 m (6 ft) uncoiled length 4-pin mmj connector at one end
Baud rate	4800
Electrical interface	EIA RS 423
Power consumption	2.0 watts maximum
Power input	12 V $\pm$ 6% at 350 ma
Volume control	8 levels, plus off
Keystroke timing	20 ms minimum

---

**Table A-5. LK401-AA Keyboard Operating Conditions**

---

Temperature range <sup>1</sup>	10°C to 40°C (50°F to 104°F)
Relative humidity	10% to 90% noncondensing
Maximum wet-bulb temperature	32°C (90°F)
Minimum dew-point temperature	15°C (60°F)
Altitude	2,400 m (8,000 ft) maximum

---

<sup>1</sup>Reduce maximum temperature by 1.8°C for each 1,000 meter (1.0°F for each 1,000 ft) increase in altitude.

---

**Table A-6. LK401-AA Keyboard Nonoperating Conditions**

---

Temperature range	-40°C to 66°C ( -40°F to 151°F)
Relative humidity	10% to 95%, noncondensing
Maximum wet-bulb temperature	52°C (126°F), packaged
Altitude	4,900 m (16,000 ft) maximum

---

## LK421-AA Keyboard Equipment Specifications

**Table A-7. LK421-AA Keyboard Description**

Weight	1.16 kg (2.56 lb)
Height	4.76 cm (1.88 in)
Width	47.80 cm (19.00 in)
Depth	19.20 cm (7.56 in)
Number of keys	108
Number of indicators	2 status LEDs
Language variations	15 Software selectable (keycaps required)
Cable	1.8 m (6 ft) uncoiled length 4-pin mmj connector at one end
Baud rate	4800
Electrical interface	EIA RS 423
Power consumption	2.0 watts maximum
Power input	12 V $\pm$ 6% at 350 ma
Volume control	8 levels, plus off
Keystroke timing	20 ms minimum

**Table A-8. LK421-AA Keyboard Operating Conditions**

Temperature range <sup>1</sup>	10°C to 40°C (50°F to 104°F)
Relative humidity	10% to 90% noncondensing
Maximum wet-bulb temperature	32°C (90°F)
Minimum dew-point temperature	15°C (60°F)
Altitude	2,400 m (8,000 ft) maximum

<sup>1</sup>Reduce maximum temperature by 1.8°C for each 1,000 meter (1.0°F for each 1,000 ft) increase in altitude.



**Table A-9. LK421-AA Keyboard Nonoperating Conditions**

---

Temperature range	-40°C to 66°C ( -40°F to 151°F)
Relative humidity	10% to 95%, noncondensing
Maximum wet-bulb temperature	52°C (126°F), packaged
Altitude	4.900 m (16.000 ft) maximum

---

## VSXXX-GA Mouse Equipment Specifications

**Table A-10. VSXXX-GA Mouse Description**

Weight	97 g (3.4 oz) without cable
Height	32.5 mm (1.28 in)
Diameter	60.9 mm (2.4 in)
Buttons	3
Cable length	1.5 m (5 ft) shielded, 5 conductors and terminals in a 7-pin micro-DIN-type connector (male)
Accuracy	$\pm 3\%$ 0 to 25 cm (0 to 10 in) per second in any direction
	$\pm 15\%$ 25 to 50 cm (10 to 20 in) per second in any direction
	$\pm 30\%$ 50 to 75 cm (20 to 30 in) per second in any direction
Baud rate	4800
Data format	Delta mode
Electrical interfaces	RS-232 or TTL
Operating modes	Incremental or polling
Power requirements	-5 V $\pm 5\%$ at 130 ma -8 to -13 V at 20 ma (RS-232 mode)
Resolution	79 counts per cm (200 counts per in)
Tracking speed	76 cm (30 in) per second
Tracking rate	In incremental mode: 55 reports per second In polling mode: up to 95 reports per second

**Table A-11. VSXXX-GA Mouse Operating Conditions**

Temperature range <sup>1</sup>	10°C to 40°C (50°F to 104°F)
Relative humidity	10% to 90% noncondensing
Maximum wet-bulb temperature	18°C (64°F)
Minimum dew-point temperature	2°C (36°F)
Altitude	3,050 m (10,000 ft) maximum

<sup>1</sup>Reduce maximum temperature by 1.8°C for each 1,000 meter (1.0°F for each 1,000 ft) increase in altitude.

**Table A-12. VSXXX-GA Mouse Nonoperating Conditions**

---

Temperature range	-40°C to 66°C ( -40°F to 151°F)
Relative humidity	5% to 95% noncondensing
Maximum wet-bulb temperature	46°C (115°F) packaged
Altitude	7,600 m (25,000 ft) maximum

---

# VSXXX-AB Tablet Equipment Specifications

**Table A-13. VSXXX-AB Tablet Description**

Weight	3.18 kg (7.00 lb)
Height	20.32 cm (8.00 in)
Width	40.64 cm (16.00 in)
Depth	41.15 cm (16.20 in)
Puck	4 buttons
Stylus	2 buttons
Cable length	1.5 m (5 ft), terminated in a 7-pin Micro-DIN-type connector
Output connector (power and data)	7-pin Micro-DIN (male)
Mating connector	7-pin Micro-DIN (female)
Active area	280 mm by 280 mm (11 in by 11 in)
Baud rate	4800 or 9600 baud (software selectable)
Electrical interfaces	Serial, asynchronous, full-duplex EIA RS-232-C signal levels
Incremental	Position reports generated when cursor is in motion and when pushbuttons are pressed or released
Operating modes	Incremental and polling
Power requirements	$\pm 12$ V dc $\pm 10\%$ at 0.3 A
Proximity (nominal)	1.27 cm (5 in) cursor
Resolution	79 counts per cm (200 counts per in) 0.63 cm (0.25 in) stylus
Remote request	X-Y coordinate update and proximity report when polled by host
Tracking rates	
- In incremental mode	55, 72, or 120 reports per second
- In polling mode	50 reports per second at 4800 baud 80 reports per second at 9600 baud

**Table A-14. VSXXX-AB Tablet Operating Conditions**

---

Temperature range <sup>1</sup>	10°C to 40°C (50°F to 104°F)
Relative humidity	20% to 80% noncondensing
Maximum wet bulb temperature	28°C (82°F)
Minimum dew point temperature	2°C (36°F)
Altitude	2400 m (8000 ft) maximum

---

<sup>1</sup>Reduce maximum temperature by 1.8°C for each 1,000 meter (1.0°F for each 1,000 ft) increase in altitude.

---

**Table A-15. VSXXX-AB Tablet Nonoperating Conditions**

---

Temperature range	-40°C to 66°C ( -40°F to 151°F)
Relative humidity	10% to 95% noncondensing
Maximum wet bulb temperature	46°C (115°F) packaged
Altitude	4900 m (16,000 ft) maximum

---

## BA42 Storage Expansion Box Equipment Specifications

**Table A-16. BA42 Storage Expansion Box Description**

Weight	17.24 kg (38.00 lb) maximum
Height	10.16 cm (4.00 in)
Width	46.02 cm (18.12 in)
Depth	40.64 cm (16.00 in)
Input voltage	Automatically adjusting ac input 120–240 Vac
Frequency range	47 to 63 Hz
Power	90 watts maximum

**Table A-17. BA42 Storage Expansion Box Operating Conditions**

Temperature range <sup>1</sup>	10°C to 40°C (50°F to 104°F)
Temperature change rate	11°C (20°F) per hour maximum
Relative humidity	20% to 80% noncondensing
Maximum wet-bulb temperature	28°C (82°F)
Minimum dew-point temperature	2°C (36°F)
Altitude	2400 m (8000 ft) maximum

<sup>1</sup>Reduce maximum temperature by 1.8°C for each 1,000 meter (1.0°F for each 1,000 ft) increase in altitude.

**Table A-18. BA42 Storage Expansion Box Nonoperating Conditions**

Temperature range	5°C to 50°C (41°F to 122°F)
Relative humidity	10% to 95% noncondensing
Maximum wet-bulb temperature	46°C (115°F) packaged
Altitude	4900 m (16,000 ft) maximum

# RZ55 SCSI Hard Disk Drive Equipment Specifications

Table A-19. RZ55 SCSI Hard Disk Drive Description

---

Expansion box	
- Weight	13.15 kg (29.00 lb)
- Height	13.97 cm (5.50 in)
- Width	32.39 cm (12.75 in)
- Depth	28.55 cm (11.25 in)
Internal drive	
- Weight	3.81 kg (8.40 lb)
- Height	8.26 cm (3.25 in)
- Width	14.61 cm (5.75 in)
- Depth	20.83 cm (8.20 in)
Capacity	
- Bytes per drive	332.3 MB
- Blocks per drive	649.040
- Block size	512 bytes
Data transfer rate	
- Bus asynchronous mode	1.5 MB per second
- Bus synchronous mode	4 MB per second
- To and from media	1.25 MB per second
Seek time	
	4 ms track-to-track
	16 ms average
	35 ms maximum
Average latency	8.3 ms
Interface	SCSI

---

**Table A-20. RZ55 SCSI Hard Disk Drive Operating Conditions**

---

Temperature range <sup>1</sup>	10°C to 55°C (50°F to 131°F)
Temperature change rate	11°C (20°F) per hour, maximum
Relative humidity	20% to 80% noncondensing
Maximum wet-bulb temperature	25.6°C (78°F)
Minimum dew-point temperature	2°C (36°F)
Altitude	-300 to 4600 m ( -1000 ft to 15,000 ft)

---

<sup>1</sup>Reduce maximum temperature by 1.8°C for each 1,000 meter (1.0°F for each 1,000 ft) increase in altitude.

---

**Table A-21. RZ55 SCSI Hard Disk Drive Nonoperating Conditions**

---

Temperature range	-40°C to 66°C ( -40°F to 151°F)
Temperature change rate	20°C (36°F) per hour, maximum
Relative humidity	20% to 95% packaged
Maximum wet-bulb temperature	46°C (115°F) packaged
Altitude	-300 to 12,200 m ( -1000 ft to 40,000 ft)

---



# RZ56 SCSI Hard Disk Drive Equipment Specifications

Table A-22. RZ56 SCSI Hard Disk Drive Description

---

Internal drive	
Weight	3.81 kg (8.40 lb)
Height	8.26 cm (3.25 in)
Width	14.61 cm (5.75 in)
Depth	20.32 cm (8.00 in)
Capacity	
– Bytes per drive	655.17 MB
– Blocks per drive	1,299,174
– Block size	512 bytes
Data transfer rate	
– Bus asynchronous mode	1.6 MB per second
– Bus synchronous mode	4.0 MB per second
– To and from media	1.875 MB per second
Seek time	4 ms track-to-track 16 ms average 35 ms maximum
Average latency	8.3 ms
Interface	SCSI

---

Table A-23. RZ56 SCSI Hard Disk Drive Operating Conditions

---

Temperature range <sup>1</sup>	10°C to 55°C (50°F to 131°F)
Temperature change rate	11°C (20°F) per hour, maximum
Relative humidity	8% to 80% noncondensing
Maximum wet-bulb temperature	25.6°C (78°F)
Minimum dew-point temperature	2°C (36°F)
Altitude	–300 to 4600 m ( –1000 to 15,000 ft)

---

<sup>1</sup>Reduce maximum temperature by 1.8°C for each 1,000 meter (1.0°F for each 1,000 ft) increase in altitude.

---

**Table A-24. RZ56 SCSI Hard Disk Drive Nonoperating Conditions**

---

Temperature range	-40°C to 66°C ( -40°F to 151°F)
Temperature change rate	20°C (36°F) per hour, maximum
Relative humidity	8% to 95% packaged
Maximum wet-bulb temperature	46°C (115°F) packaged
Altitude	-300 to 12,200 m ( -1000 to 40,000 ft)

---

# RZ57 SCSI Hard Disk Drive Equipment Specifications

**Table A-25. RZ57 SCSI Hard Disk Drive Description**

---

Internal drive	
- Weight	3.81 kg (8.40 lb)
- Height	8.26 cm (3.25 in)
- Width	14.61 cm (5.75 in)
- Depth	20.32 cm (8.00 in)
Capacity	
- Bytes per drive	1.0 gigabytes
- Blocks per drive	1,954,050
- Block size	512 bytes
Data transfer rate	
- Bus asynchronous mode	1.6 MB per second
- Bus synchronous mode	4.0 MB per second
- To and from media	2.5 MB per second
Seek time	
	4 ms track-to-track
	14.5 ms average
	33 ms maximum
Average latency	8.3 ms
Interface	SCSI

---

**Table A-26. RZ57 SCSI Hard Disk Drive Operating Conditions**

---

Temperature range <sup>1</sup>	10°C to 55°C (50°F to 131°F)
Temperature change rate	11°C (20°F) per hour, maximum
Relative humidity	8% to 80%, noncondensing
Maximum wet-bulb temperature	26°C (78°F)
Minimum dew-point temperature	2°C (36°F)
Altitude	-300 to 4600 m ( -1000 to 15,000 ft)

---

<sup>1</sup>Reduce maximum temperature by 1.8°C for each 1,000 meter (1.0°F for each 1,000 ft) increase in altitude.

---

**Table A-27. RZ57 SCSI Hard Disk Drive Nonoperating Conditions**

---

Temperature range	-40°C to 66°C ( -40°F to 151°F)
Temperature change rate	20°C (36°F) per hour, maximum
Relative humidity	8% to 95%, packaged
Maximum wet-bulb temperature	46°C (115°F), packaged
Altitude	-300 to 12,200 m ( -1000 to 40,000 ft)

---

## RZ58 SCSI Hard Disk Drive Equipment Specifications

Table A-28. RZ58 SCSI Hard Disk Drive Description

---

Internal drive	
- Weight	3.81 kg (8.40 lb)
- Height	8.26 cm (3.25 in)
- Width	14.61 cm (5.75 in)
- Depth	20.32 cm (8.00 in)
Capacity	
- Bytes per drive	1.38 gigabytes
- Blocks per drive	2,698,061 not including spares
- Block size	512 bytes
Data transfer rate	
- Bus asynchronous mode	1.6 MB per second
- Bus synchronous mode	5.0 MB per second
- To and from media	2.5 MB per second
Seek time	2.5 ms track-to-track 12.5 ms average 25 ms maximum
Average latency	5.6 ms
Interface	SCSI II

---

Table A-29. RZ58 SCSI Hard Disk Drive Operating Conditions

---

Temperature range <sup>1</sup>	10°C to 55°C (50°F to 131°F)
Temperature change rate	11°C (20°F) per hour, maximum
Relative humidity	8% to 80%
Maximum wet-bulb temperature	26°C (78°F)
Minimum dew-point temperature	2°C (36°F)
Altitude	-300 to 4600 m ( -1000 to 15,000 ft)

---

<sup>1</sup>Reduce maximum temperature by 1.8°C for each 1,000 meter (1.0°F for each 1,000 ft) increase in altitude.

---

**Table A-30. RZ58 SCSI Hard Disk Drive Nonoperating Conditions**

---

Temperature range	-40°C to 66°C ( -40°F to 151°F)
Temperature change rate	20°C (36°F) per hour, maximum
Relative humidity	8% to 95%, packaged
Maximum wet-bulb temperature	46°C (115°F), packaged
Altitude	-300 to 12.200 m ( -1000 to 40.000 ft)

---

# TK50Z Tape Drive Equipment Specifications

**Table A-31. TK50Z Tape Drive Description**

---

Expansion box	
- Weight	12.70 kg (28.00 lb)
- Height	13.97 cm (5.50 in)
- Width	32.39 cm (12.75 in)
- Depth	28.58 cm (11.25 in)
Bit density	6,667 bits per in
Cartridge capacity	95 MB approximate
Frequency	50 to 60 Hz
Heat dissipation	32 watts maximum
Input current	2.4 A: 100 to 120 Vac 1.3 A: 220 to 240 Vac
Media	12.77 mm (0.5 in), 183 m (600 ft) long magnetic tape
Mode of operation	Streaming
Number of tracks	22
Power	160 watts
Track format	Serpentine
Data transfer rate	360 Kbits per second (45 KB per second)
Tape speed	75 in per second

---

**Table A-32. TK50Z Tape Drive Operating Conditions**

---

Temperature range <sup>1</sup>	10°C to 40°C (50°F to 104°F)
Temperature change rate	11°C (20°F) per hour, maximum
Relative humidity	10% to 80% noncondensing
Maximum wet-bulb temperature	28°C (82°F)
Minimum dew-point temperature	2°C (36°F)
Altitude	2,400 m (8,000 ft) maximum

---

<sup>1</sup>Reduce maximum temperature by 1.8°C for each 1,000 meter (1.0°F for each 1,000 ft) increase in altitude.

---

**Table A-33. TK50Z Tape Drive Nonoperating Conditions**

---

Temperature range	-30°C to 66°C ( -22°F to 151°F)
Temperature change rate	20°C (36°F) per hour, maximum
Relative humidity	10% to 95% noncondensing
Maximum wet-bulb temperature	46°C (115°F) packaged
Altitude	9,140 m (30,000 ft) maximum

---



# TZ30 Tape Drive Equipment Specifications

**Table A-34. TZ30 Tape Drive Description**

---

Internal drive	
- Weight	1.50 kg (3.31 lb)
- Height	4.14 cm (1.63 in)
- Width	14.48 cm (5.70 in)
- Depth	21.59 cm (8.50 in)
Bit density	2624 bits per cm (6667 bits per in)
Cartridge capacity	95 Mbytes, formatted (approximate)
Media	12.77 mm (0.5 in) unformatted magnetic tape
Mode of operation	Streaming
Number of tracks	22
Tape speed	190 cm per second (75 in per second)
Track format	Multiple track serpentine recording
Data transfer rate	62.5 Kbytes per second

---

**Table A-35. TZ30 Tape Drive Operating Conditions**

---

Temperature range <sup>1</sup>	10°C to 40°C (50°F to 104°F)
Temperature change rate	11°C (20°F) per hour, maximum
Relative humidity	20% to 80% noncondensing
Maximum wet-bulb temperature	25°C (77°F)
Minimum dew-point temperature	2°C (36°F)
Altitude	2400 m (8000 ft) maximum

---

<sup>1</sup>Reduce maximum temperature by 1.8°C for each 1,000 meter (1.0°F for each 1,000 ft) increase in altitude.

---

**Table A-36. TZ30 Tape Drive Nonoperating Conditions**

---

Temperature range	-40°C to 66°C ( -40°F to 151°F)
Temperature change rate	20°C (36°F) per hour, maximum
Relative humidity	10% to 95%
Maximum wet-bulb temperature	2°C (36°F)
Altitude	9100 m (30,000 ft) maximum

---

# TZK10 QIC Tape Drive Equipment Specifications

**Table A-37. TZK10 QIC Tape Drive Description**

---

Internal drive	
- Weight	1.09 kg (2.40 lb)
- Height	4.39 cm (1.73 in)
- Width	14.61 cm (5.75 in)
- Depth	20.83 cm (8.20 in)
Cartridge capacity	320 MB (approximate) with DC6320 525 MB (approximate) with DC6525
Data density	16,000 bits per in
Drive interface	SCSI-2
Media	DC6320, DC6525, or Digital-approved equivalent
Mode of operation	Streaming
Number of tracks	26
Power consumption, normal	20 watts
Power consumption, peak	33 watts
Transfer rate	200 KB per second at average streaming mode 1.5 MB per second at SCSI maximum
Tape speed	305 cm (120 in) per second
Track format	Multiple track serpentine recording

---

**Table A-38. TZK10 QIC Tape Drive Operating Conditions**

---

Temperature range <sup>1</sup>	5°C to 40°C (50°F to 104°F)
Temperature change rate	11°C (20°F) per hour, maximum
Relative humidity	2% to 80% noncondensing
Maximum wet-bulb temperature	28°C (82°F)
Minimum dew-point temperature	2°C (36°F)
Altitude	3900 m (13,000 ft) maximum

---

<sup>1</sup>Reduce maximum temperature by 1.8°C for each 1,000 meter (1.0°F for each 1,000 ft) increase in altitude.

---

**Table A-39. TZK10 QIC Tape Drive Nonoperating Conditions**

Temperature range	-30°C to 60°C (-22°F to 151°F)
Temperature change rate	20°C (36°F) per hour, maximum
Relative humidity	10% to 95%
Maximum wet-bulb temperature	46°C (115°F)
Altitude	12,200 m (40,000 ft) maximum

# TLZ04 Cassette Tape Drive Equipment Specifications

**Table A-40. TLZ04 Cassette Tape Drive Description**

---

Expansion box	
- Weight	7.7 kg (17.00 lb)
- Height	11.50 cm (4.50 in)
- Width	35.00 cm (14.00 in)
- Depth	30.00 cm (12.00 in)
Cassette capacity	1.2 gigabyte
Drive interface	SCSI
Media	TLZ04-CA cassette tape
Mode of operation	Streaming and start/stop
Power consumption	230 watts
Power requirements	1.6 A: 100 to 120 Vac 1.0 A: 200 to 240 Vac
Track format	Digital data storage (DDS)
Transfer rate	156 KB per second

---

**Table A-41. TLZ04 Cassette Tape Drive Operating Conditions**

---

Temperature range <sup>1</sup>	10°C to 40°C (50°F to 104°F)
Relative humidity	20% to 80% noncondensing
Altitude	0 m to 4600 m (0 to 15,000 ft)

---

<sup>1</sup>Reduce maximum temperature by 1.8°C for each 1,000 meter (1.0°F for each 1,000 ft) increase in altitude.

---

**Table A-42. TLZ04 Cassette Tape Drive Nonoperating Conditions**

---

Temperature range	-40°C to 70°C (40°F to 155°F)
Relative humidity	5% to 95% noncondensing
Altitude	0 m to 15,200 m (0 to 50,000 ft)

---

## RRD42 Compact Disc Drive Equipment Specifications

**Table A-43. RRD42 Compact Disc Drive Description**

---

RRD42-AA	
- Weight	1.3 kg (2.8 lb)
- Height	4.15 cm (1.63 in)
- Width	14.60 cm (5.75 in)
- Depth	20.81 cm (8.2 in)
Capacity	600 MB
Seek time	450 ms average (typical) 700 ms maximum (typical)
Burst transfer rate	1.5 MB per second
Sustained transfer rate	150 KB per second
Heat dissipation	14 watts (typical)
Initialization startup time	2.0 seconds maximum
Interface	SCSI

---

**Table A-44. RRD42 Compact Disc Drive Operating Conditions**

---

Temperature range <sup>1</sup>	5°C to 50°C (41°F to 122°F)
Relative humidity	10% to 90% noncondensing
Maximum wet-bulb temperature	28°C (82°F)
Minimum dew-point temperature	2°C (36°F)
Altitude	-300 to 4600 m ( -1000 to 15,000 ft)

---

<sup>1</sup> Reduce maximum temperature by 1.8°C for each 1,000 meter (1.0°F for each 1,000 ft) increase in altitude.

---

**Table A-45. RRD42 Compact Disc Drive Nonoperating Conditions**

---

Temperature range	-30 °C to 55°C ( -22°F to 131°F)
Relative humidity	10 to 90% packaged, noncondensing
Maximum wet-bulb temperature	46°C (115°F) packaged, noncondensing
Altitude	-300 to 12,200 m ( -1000 to 40,000 ft)

---

## RX23 Diskette Drive Equipment Specifications

Table A-46. RX23 Diskette Drive Description

---

Internal drive	
- Weight	0.48 kg (1.06 lb)
- Height	3.00 cm (1.18 in)
- Width	10.16 cm (4.00 in)
- Depth	15.01 cm (5.91 in)
Number of tracks	80
Number of heads	2
Step rate	3 ms per track
Diskette size	8.9 cm (3.5 in)
Recording surfaces per diskette	2
Sectors per track	9 double density 18 high density
Capacity	
- Bytes per drive	737 KB double density 1,474 KB high density
- Blocks per drive	1,440 double density 2,880 high density
- Block size	512 bytes
Data transfer rate	
- To and from media	250 Kbits per second double density 500 Kbits per second high density
Operating power	3.0 watts
Standby power	0.3 watts

---

**Table A-47. RX23 Diskette Drive Operating Conditions**

---

Temperature range <sup>1</sup>	5°C to 50°C (40°F to 122°F)
Temperature change rate	11°C (20°F) per hour, maximum
Relative humidity	8% to 80%, noncondensing
Maximum wet-bulb temperature	29°C (80°F)
Minimum dew-point temperature	2°C (36°F)
Altitude	-300 to 3060 m ( -1,000 ft to 10,000 ft)

---

<sup>1</sup>Reduce maximum temperature by 1.8°C for each 1,000 meter (1.0°F for each 1,000 ft) increase in altitude.

---

**Table A-48. RX23 Diskette Drive Nonoperating Conditions**

---

Temperature	-40°C to 66°C ( -40°F to 151°F)
Temperature change rate	20°C (36°F) per hour, maximum
Relative humidity	5% to 95%, packaged
Maximum wet-bulb temperature	46°C (115°F), packaged
Altitude	-300 to 12,300 m ( -1,000 ft to 40,000 ft)

---



# RX33 Diskette Drive Equipment Specifications

Table A-49. RX33 Diskette Drive Description

---

Internal drive	
- Weight	1.10 kg (2.43 lb)
- Height	4.32 cm (1.70 in)
- Width	14.61 cm (5.75 in)
- Depth	20.32 cm (8.00 in)
Number of tracks	80
Number of heads	2
Track density	96 tracks per inch
Step rate	3 ms per track
Diskette size	13.13 cm (5.25 in)
Recording surfaces per diskette	2
Sectors per track	10 normal density 15 high density
Capacity	
- Bytes per drive	409 KB normal density 1200 KB high density
- Blocks per drive	800 normal density 2400 high density
- Block size	512 bytes
Data transfer rate	
- To and from media	250 Kbits per second normal density 500 Kbits per second high density
Operating power	4.1 watts
Standby power	1.5 watts

---

**Table A-50. RX33 Diskette Drive Operating Conditions**

---

Temperature range <sup>1</sup>	10°C to 46°C (50°F to 115°F)
Temperature change rate	11°C (20°F) per hour, maximum
Relative humidity	20% to 80% noncondensing
Maximum wet-bulb temperature	45°C (113°F)
Minimum dew-point temperature	2°C (36°F)
Altitude	2400 m (8000 ft) maximum

---

<sup>1</sup>Reduce maximum temperature by 1.8°C for each 1,000 meter (1.0°F for each 1,000 ft) increase in altitude.

---

**Table A-51. RX33 Diskette Drive Nonoperating Conditions**

---

Temperature	-34°C to 60°C (-30°F to 140°F)
Temperature change rate	20°C (36°F) per hour, maximum
Relative humidity	5% to 90%
Maximum wet-bulb temperature	45°C (113°F) packaged
Altitude	9100 m (30,000 ft) maximum

---

# B

---

## Part Numbers

This appendix lists the order numbers for the following components and options for the DECstation 5000 Model 240 workstation:

- Basic workstation components (Table B-1)
- User-replaceable modules in the system unit (Table B-2)
- Cords and cables (Table B-3)
- Adapters, connectors, and terminators (Table B-4)
- Software documentation (Table B-5)
- Hardware documentation (Table B-6)

For more information on any item, see the *DECdirect Desktop Edition* catalog.

**Table B-1. Basic Components**

Item	Order Number
External Storage Devices (see the <i>DECdirect Desktop Edition</i> catalog)	
Keyboard (full-sized)	LK401-AA
Keyboard (small)	LK421-AA
Monitors (see the <i>DECdirect Desktop Edition</i> catalog)	
Mouse	VSXXX-GA
Tablet	VSXXX-AB
Terminals (see the <i>DECdirect Desktop Edition</i> catalog)	

**Table B-2. User-replaceable Modules in the System Unit**

Item	Order Number
CPU module, 40 MHz	KN03-GA
Memory module (SIMM), 8Mbyte	MS02-AA
Memory module (SIMM), 32Mbyte	MS02-CA
NVRAM module, 1Mbyte	MS02-NV
TURBOchannel option modules (see the <i>DECdirect Desktop Edition</i> catalog)	

**Table B-3. Cords and Cables**

<b>Item</b>	<b>Order Number</b>
Keyboard-mouse cable (comes with workstation)	N/A
Monitor-to-system-unit power cable (Europe)	BN19P-K
Monitor-to-system-unit power cable (U.S.) (comes with workstation)	N/A
Power cord for system unit, monitor, or expansion box	
- for North America, Japan, Mexico - 120 V	BN19P-1K
- for UK, Ireland - 240 V	BN19A-2E
- for Austria, Belgium, Finland, France, Germany, Holland, Norway, Portugal, Spain, Sweden - 220 V	BN19C-2E
- for Switzerland - 220 V	BN19E-2E
- for Australia, New Zealand - 240/230 V	BN19H-2E
- for Denmark - 220 V	BN19K-2E
- for Italy - 220 V	BN19M-2E
- for India, South Africa - 220 V	BN19S-2E
- for Israel - 240 V	BN18L-2E
SCSI Cables	
- Expansion-box-to-expansion-box SCSI cable	BC19J-1E
- System-unit-to-expansion-box SCSI cable	BC09D-06
- System-unit-to-TCE SCSI cable	BC19J-1E
- TCE-to-expansion-box SCSI cable	BC09D-06
Serial line cable	BC16E-10
System-unit-to-TCE TURBOchannel interface cable (comes with TCE)	N/A
ThickWire Ethernet cable	BNE4C-02
ThinWire Ethernet cable (15 or 30 ft)	BC16M-15/30
ThinWire LAN assembly kit	BC16T-12
Twisted-pair Ethernet cable (comes in kit)	N/A
Twisted-pair LAN assembly kit	DEMPR-CA/CBA
Video cable, color	BC29G-03
Video cable, gray scale	BC09M-10
Video cable, monochrome (comes with monitor)	N/A

**Table B-4. Adapters, Connectors, and Terminators**

Item	Order Number
Communications connector adapter (comes with workstation)	N/A
Communications loopback connector	H3200
SCSI expansion box (drive) terminator (comes with expansion box)	N/A
ThickWire loopback connector (comes with workstation)	N/A
ThickWire-to-ThinWire Ethernet adapter	DESTA-BA
ThickWire-to-twisted-pair Ethernet adapter	H3350-AA
ThinWire T-connector	H8223
ThinWire T-connector terminator	H8225

**Table B-5. Software Documentation**

Item	Order Number
<b>ULTRIX Media and Doc-TK50</b>	QA-VV1AA-H5
<i>ULTRIX Guide to the Error Logger</i>	AE-ME95B-TE
<i>Technical Summary for RISC Processors</i>	AA-MM35A-TE
<i>Documentation Overview for RISC Processors</i>	AA-MM05A-TE

**Table B-6. Hardware Documentation**

<b>Item</b>	<b>Order Number</b>
<b>DECstation 5000 Model 240 User Documentation Kit</b>	<b>EK-PM38A-DK</b>
<i>DECstation 5000 Model 240 Hardware Installation Guide</i>	<b>EK-PM38B-IN</b>
<i>DECstation 5000 Model 240 Hardware Operator's Guide</i>	<b>EK-PM38C-OG</b>
<i>DECstation 5000 Model 240 Workstation Reference Card</i>	<b>EK-PM38D-RC</b>
<i>DECstation 5000 Model 240 Maintenance Guide</i>	<b>EK-PM38G-MG</b>
<i>DECstation 5000 Model 240 Field Service Pocket Guide</i>	<b>EK-PM38E-PS</b>
 <b>Components and Add-Ons</b>	
<i>The RZ55 Disk Drive Service Manual</i>	<b>EK-RZ55D-SV</b>
<i>The RZ56 Disk Drive Subsystem Service Manual</i>	<b>EK-RZ56D-SV</b>
<i>The RZ57 Disk Drive Subsystem Service Manual</i>	<b>EK-RZ57D-SV</b>
<i>The RRD42 Owner's Manual</i>	<b>EK-RRD40-OM</b>
<i>The TLZ04 Cassette Tape Drive Owner's Manual</i>	<b>EK-TLZ04-OM</b>
<i>Installing and Using the LN03</i>	<b>EK-0LN03-UG</b>
<i>LN03 PLUS User Guide</i>	<b>EK-LN03S-UG</b>
<i>ScriptPrinter Installation Guide</i>	<b>EK-LN03R-UG</b>
<i>ScriptPrinter Operator Guide</i>	<b>EK-LN03R-OG</b>
<i>LA100 Letterwriter User Documentation Kit</i>	<b>EK-LW100-UG</b>
<i>Installing and Using the LA75 Companion Printer</i>	<b>EK-0LA75-UG</b>
<i>Installing and Using the LJ250/252 Companion Color Printer</i>	<b>EK-LJ250-DK</b>
<i>TK50Z Tape Drive Subsystem Owner's Manual</i>	<b>EK-LEP05-OM</b>
<i>TK50Z User's Guide</i>	<b>EK-OTK50-UG</b>
<i>TK50Z Technical Manual</i>	<b>EK-OTK50-TM</b>





---

## Connector Pin Assignments

This appendix lists pin assignments for the following connectors:

- SCSI cable connectors
- Keyboard and mouse or tablet
- Communications
- ThickWire Ethernet
- Power supply
- Modem loopback
- Ethernet loopback

It also provides a

- Summary of loopback connectors

**Table C-1. SCSI Cable Connector Pin Assignments**

Pin	Signal	Pin	Signal
50	~ I/O	25	GND
49	~ REQ	24	GND
48	~ C/O	23	GND
47	~ SEL	22	GND
46	~ MSG	21	GND
45	~ RST	20	GND
44	~ ACK	19	GND
43	~ BSY	18	GND
42	GND	17	GND
41	~ ATN	16	GND
40	GND	15	GND
39	RSVD	14	GND
38	TERMPWR	13	NC
37	RSVD	12	GND
36	GND	11	GND
35	GND	10	GND
34	~ PARITY	9	GND
33	~ DATA<7>	8	GND
32	~ DATA<6>	7	GND
31	~ DATA<5>	6	GND
30	~ DATA<4>	5	GND
29	~ DATA<3>	4	GND
28	~ DATA<2>	3	GND
27	~ DATA<1>	2	GND
26	~ DATA<0>	1	GND

**Table C-2. Keyboard and Mouse or Tablet Connector Pin Assignments**

Pin	Source	Signal	Description
1		GND	Ground
2		KEY.TX	Keyboard transmitted data
3	Keyboard	KEY.RX	Keyboard received data
4		+12V	Keyboard/tablet power
5		GND	Ground
6	Mouse/Tablet	MSE.RX	Mouse received data
7		MSE.TX	Mouse transmitted data
8		GND	Ground
9		GND	Ground
10		NC	
11		NC	
12		NC	
13		+5V	Mouse power
14		-12V	Mouse power
15		GND	Ground

**Table C-3. Communications Connectors Pin Assignments**

Pin	Source	Signal	CCITT <sup>1</sup>	EIA <sup>2</sup>	Description
1		GND	102	AB	Signal ground
2	KNO3A-AA	TX	103	BA	Modem transmitted data
3	Modem/printer	RX	104	BB	Modem received data
4	KNO3A-AA	RTS	105	CA	Request to send
5	Modem/printer	CTS	106	CB	Clear to send
6	Modem/printer	DSR	107	CC	Data set ready
7		GND	102	AB	Signal ground
8	Modem/printer	CD	109	CF	Carrier detector
9					Unconnected
10					Unconnected
11					Unconnected
12	Modem/printer	SI	112	CI	SPDMI
13					Unconnected
14					Unconnected
15	Modem/printer	TxCk (DCE)	114	DB	Modem transmit clock
16					Unconnected
17	Modem/printer	RxCk (DEC)	115	DD	Modem transmit clock
18					Unconnected
19					Unconnected
20	KNO3A-AA	DTR	108.2	CD	Data terminal ready
21					Unconnected
22	Modem/printer	RI	125	CE	Ring indicator
23	KNO3A-AA	SS	111	CH	DSRS
24					Unconnected
25					Unconnected

<sup>1</sup>Comite Consultatif International Telegraphique et Telephonique, an international consultative committee that sets international communications standards

<sup>2</sup>Electronic Industries Association

**Table C-4. ThickWire Ethernet Connector Pin Assignments**

Pin	Source	Signal	Description
1			Shield
2	XCVR	ACOL+	Collision presence
3	KNO3A-AA	ATX+	Transmission
4		GND	Ground
5	XCVR	ARX+	Reception
6	XCVR	GND	Power return
7		CTL+	Control output
8		GND	Ground
9	XCVR	ACOL-	Collision presence
10	KNO3A-AA	ATX-	Transmission
11		GND	Ground
12	XCVR	ARX-	Reception
13	KNO3A-AA	+12V	Power
14		GND	Ground
15		CTL-	Control output

**Table C-5. Power Supply Pin Assignments**

Pin	Signal	Wire Gauge
1	+12 volt	18
2	Ground	18
3	-12 volt	22
4	Ground	22
5	POK	22
6	Warning	22

**Table C-6. Modem Loopback Connector Pin Assignments**

From Pin No.	Signal	To Pin No.	Signal
P4-2	TX2	P4-3	RX2
P4-4	RTS2	P4-5	CTS2
P4-6	DSR2	P4-20	DTR2
P4-12	SPDMI2	P4-23	DSRS2
P4-18	LLPBK2	P4-8	CI2
P4-18	LLPBK2	P4-22	RI2
P4-18	LLPBK2	P4-25	TMI2

**Table C-7. Ethernet Loopback Connector Pin Assignments**

From Pin No.	Signal	To Pin No.	Signal	Description
P6-3	TRA+	P6-5	REC+	Through capacitor
P6-10	TRA-	P6-12	REC-	Through capacitor
P6-13	PWR	P6-6	RET	Through resistor and LED

**Table C-8. Summary of Loopback Connectors**

Function	Standard/ Unique	Option Number
Communications loopback connector	Standard	H3200
ThickWire loopback connector	Standard	N/A
ThinWire T-connector	Standard	H8223
ThinWire terminator	Standard	H8225

# D

## Regulatory Information for the UK

This document provides user information on the DECstation 5000 Model 240 Series workstation that is required by the United Kingdom.

The DECstation 5000 Model 240 Series workstation is manufactured by Digital Equipment Corporation. The model number of the communication option is KN03A-AA.

### Service Requirements

The following table describes the service category, interface type, data rate, service requirements, and PTO for the KN03A-AA.

Table D-1. KN03A-AA service requirements

Service Category	Interface Type	Data Rate	Physical Requirements	Electrical Requirements	PTO BT <sup>1</sup> /MCL <sup>2</sup> /Hull <sup>3</sup>
1	CCITT	2400	ISO 2110	V.24/V.28	Yes/Yes/Yes
	Recommend	4800			Yes/Yes/Yes
	X.21bis	9600	BS.6623:	Cable:	Yes/Yes/Yes
		19200	Part 1 1985	BC13P-10	No/No/Yes

<sup>1</sup>BT - British Telecommunications plc

<sup>2</sup>Hull - Kingston Communications (Hull) plc

<sup>3</sup>MCL - Mercury Communications Limited.

The maximum approved cable length is 10 feet, comprising:

Cat 1 V.24 10 feet for extension BC13P-10

### **Communication Port Pin Assignments**

See Appendix C of the DECstation 5000 Model 240 Series Hardware Operator's Guide for information on the communication port pin assignments.

### **Approvals for Digital Circuits**

The KN03A-AA is approved for direct connection to a particular digital circuit. This approval includes interconnecting cable with mating connectors conforming to BS6623 part 1 and part 4.

If the product is connected to the service with anything other than its own approved cables, then those cables must benefit from the relevant general approval and/or conform with any other applicable requirements.

**Caution::** Ports J5, J9, J10, J11, J12, J17, J19, J31, J49, J51, E1, and E3 (shown in the diagram attached to the end of this document) do not provide sufficient isolation to satisfy the requirements of the relevant parts of standard BS6301. Any product connected to these ports must meet one of the following conditions:

- *Be covered by OFTEL's General Approval NS/G/1234/J/100003. All products supplied by Digital comply with this General Approval*
- *Have been approved to the relevant parts of standard BS6301*
- *Have previously been evaluated against the British Telecom (Post Office) Technical Guide 2 or 26 and given permission to attach*

*Other usage will invalidate any approval given to this apparatus.*

*Interconnection directly, or by way of other apparatus, of ports marked by the safety warning label with other ports that are marked or not so marked, may produce hazardous conditions on the network. Seek advice from a competent engineer before making any such connection.*



## Host Independent Approvals

The KN03A-AA is approved only for installation in an approved host with approved attachments. For approval, the host and host attachments must be either of the following:

- Type-approved (meaning the equipment is built exactly like the models that were originally approved.)
- If the equipment was supplied after 1st March 1989, it must be marked with or supplied with a statement that the host is supplied under General Approval Number NS/G/1234/J/100003.

Except at the edge connector which plugs into the host's expansion slot, clearance and creepage distances of Xmm and Ymm, as listed below must be maintained between the KN03A-AA and other parts of the host, including any other expansion cards fitted.

**Table D-2. Clearance and Creepage Specs for KN03A-AA**

Clearance Xmm	Creepage Ymm	Voltage <sup>1</sup>
2.0	2.4 (3.8)	up to 50
2.6	3.0 (4.8)	up to 125
4.0	5.0 (8.0)	up to 250
4.0	6.4 (10.0)	up to 300

<sup>1</sup>Used or generated by other parts of the host or expansion card (Vrms or Vdc)

The creepage distances apply when installed in a normal office environment. The creepage distance shown in parentheses apply where the local environment within the Host Computer is subject to conductive pollution or dry non-conductive pollution which could become conductive due to condensation. These distances can be checked by measuring between the adjacent parts.

If in doubt, advice should be obtained from a competent telecom safety engineer. Failure to install the KN03A-AA in accordance with these instructions will invalidate the approval.

## Host Power Rating

The user must ensure that the power drawn by the KN03A-AA together with the host and other auxiliary apparatus drawing power from the host, is within the rating of the host power supply.

Digital has designed all permutations of the host configuration to operate within the limits of the host power rating.

The module power rating is:

**Table D-3. Module Power Rating for KN03A-AA**

Supply (+/- 4%) (Volts)	Maximum Current ( Amps)	Typical Current (Amps)
+5.1	22	7
+12.1	1.6	0.09
-12.1	0.1	0.05

## Power Supply Characteristics

Electrical output from the H7878-A power supply in the DECstation 5000 Model 240 has the following characteristics:

**Table D-4. H7878-A Power Supply Output Characteristics**

Parameter	Requirement			Units
	Minimum	Typical	Maximum	
+5.1V (short-term regulation)	+4.95	+5.10	+5.20	Volts
+5.1V (long-term regulation)	+4.90	+5.10	+5.25	Volts
+12.1V (short-term regulation)	+11.86	+12.10	+12.34	Volts
+12.1V (long-term regulation)	+11.74	+12.10	+12.46	Volts
-12V	-1.40	-12.00	-12.60	Volts
Load range				
+5.1V	3.0	-	40.0	Amps
+12.1V	0.0	-	2.7	Amps
-12V	0.0	-	0.2	Amps
Output ripple/noise,				
+5.1V	-	30.0	50.0	mV
1Hz to 10MHz, +12.1V	-	50.0	70.0	mV
1Hz to 10MHz, +12.1V fan	-	70.0	100.0	mV
1Hz to 10MHz, -12.1V	-	-	120.0	mV
All output (except +5.1V) ripple/noise, 10MHz to 50MHz	-	1.0	2.0	%
+5.1V output ripple/noise, 10MHz to 50MHz	-	-	50	mV
Temperature coefficient	-	0.02	-	% /C

Table D-4 applies to all AC line input conditions per Table A-1. Individual output regulation specifications are valid at all other specified output loadings at the output connector.

Noise and ripple are peak to peak to be measured as follows:

- Input voltages within specified operating ranges.
- Loads on all outputs within specified ranges.
- Measurement taken with Tektronix P6046 probe and an oscilloscope (minimum 100 MHz bandwidth.)
- Loads to be resistive.
- Measurement taken at load side of output connector using "Bendix" type connectors (recommended) with very short leads. The measurements will be taken with a 10uf tantalum capacitor terminated in both minimum and maximum resistive loads.
- This measurement is for use during qualification during testing.

#### **Dynamic load regulation**

Dynamic load regulation for +5.1V shall be 100 mV peak and 2 ms maximum.

Dynamic load regulation for +12.1V shall be 240 mV peak and 2 ms maximum.

This load regulation is expressed as the peak deviation from the steady-state DC-output voltage, and the time required for the output voltage to settle back to within 0.5% of its new steady-state value after an instantaneous change in the output current, with all other factors held constant. The instantaneous voltage shall not exceed the total regulation limit.

#### **DI/DT load steps**

DI/DT load steps for +5.1V shall be 0.06A/uS for a 15A step.

DI/DT load step for +12.1V shall be 0.2A/uS for 0.6A to 1.0A.

The rate of change of load current which may be stepped while keeping the output voltages in regulation. Current steps are either positive or negative going and shall be within the limits specified. The time period between steps shall not be less than three times the settling time specified in the previous section, "Dynamic Load Regulation."

### Environmental Conditions

See Appendix A in the DECstation 5000 Model 240 Series Hardware Operator's Guide for further environmental information.

## Unsupported System Module Ports

Figure D-1 is the unit assembly drawing for DECstation 5000 Model 240 system module. Shaded areas indicate ports that are not supported.

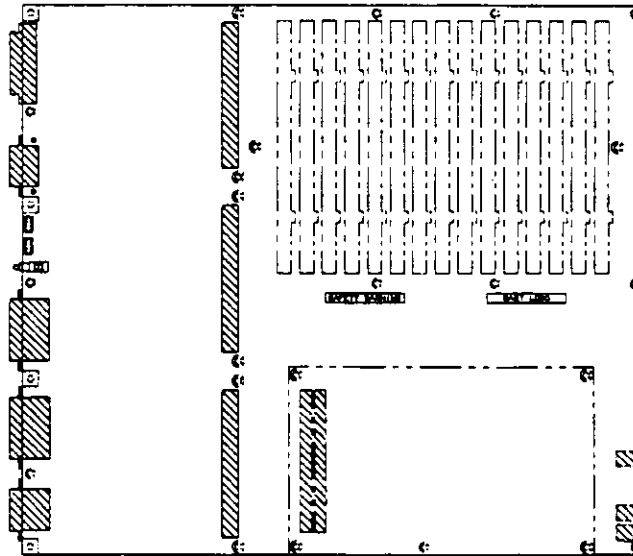

Figure D-1. Unsupported ports on the DECstation 5000 Model 240 system module



---

# Index

## A

### Adapters

- communications, 7-3, 7-6
- ThinWire Ethernet, 6-11
- Twisted-pair Ethernet, 6-15

Antistatic wrist strap, 8-8

## B

BA42 expansion box, 5-2 to 5-13

Base system module, 8-3

boot (console command), 10-11 to 10-12

boot (environment variable), 10-12, 10-21, 10-24

Booting the workstation

*See* Turning on the workstation

Button Box, 1-32

## C

### Cables

*See also* Adapters, Connectors, Part numbers, Pin assignments

*See under* Ethernet, Monitors, Power, SCSI

cat (console command), 10-12

cnfg (console command), 10-13 to 10-17

### Communications devices

- adapters for, 7-3, 7-6
- baud rate, 7-2
- connectors, 1-2, 7-2 to 7-6
- installing, 7-1 to 7-8
- troubleshooting, 11-18

Configuration display, 3-7

*See also* cnfg (console command)

Connector pin assignments, C-1 to C-6

Ethernet loopback connector, C-6

I/O cover SCSI cable, C-2

keyboard/mouse/tablet connector, C-3

modem loopback connector, C-5

printer/communications connector, C-4

printer/console loopback connector, C-5

summary of loopback connectors, C-6

ThickWire Ethernet connector, C-4

### Connectors

*See also* Adapters, Connector pin assignments, Terminators

communications, 1-2, 1-5, 7-2 to 7-6

Ethernet, 1-5, 6-2

Ethernet connector sliding lock, 6-3

Ethernet ThickWire loopback connector, 1-7, 6-2 to 6-3

keyboard-mouse, 1-5

## Connectors (Cont.)

- monitor-to-system-unit power, 1-5
- on system unit, 1-4
- SCSI, 1-5, 5-2
- system-unit power, 1-5
- video, 1-9

## Console

See System console

console (environment variable), 3-5,  
10-6 to 10-7, 10-24

? (console command), 10-11

## Console command conventions

- rules for typing, 10-8
- syntax conventions, 10-9

## Console commands, 10-10 to 10-23

- boot, 10-11 to 10-12
- cat, 10-12
- cnfg, 10-13 to 10-17
- d or deposit, 10-17 to 10-18
- e or examine, 10-18 to 10-19
- erl, 10-19
- go, 10-19
- ? (help), 10-11
- init, 10-19
- ls, 10-20
- passwd, 10-20 to 10-21
- printenv, 10-21
- restart, 10-21
- script, 10-22
- setenv, 10-22
- sh or shell, 10-22 to 10-23
- t or test, 10-23
- unsetenv, 10-23

Console mode, 10-2 to 10-3

Console password, 10-20 to 10-21

Console prompts, 3-4

## Conventions

- console command syntax, 10-9
- used in the manual, xiv

Cover-release screw, 1-5

## CPU module

- description of, 8-4
- installing, 9-16 to 9-17
- removing, 9-14 to 9-15

## CPU module (Cont.)

testing, 9-18

troubleshooting, 11-20, 11-22, 11-24

Customer Support Center, 11-3

## D

Device code, 5-17, 10-16

Device descriptor, 10-16

## Diagnostic LED display

- on system unit, 1-5
- troubleshooting the workstation,  
11-4

Dial Box, 1-32

## Diskette drives

See Drives, Equipment specifications,  
External storage devices

d or deposit (console command), 10-17  
to 10-18

## Drives

See also Equipment specifications,  
External storage devices

connecting to workstation, 5-1 to  
5-13

installing in expansion boxes, 5-19  
SCSI IDs for, 5-3, 5-4, 5-15 to 5-16  
self-contained, 5-2

## E

Electrical and magnetic interference,  
2-2

## Electrical power

See Power cables and cords,  
Power indicator light, Power  
requirements for the workstation,  
Power switches

Environment requirements, 2-1 to 2-3

## Environment variables, 10-24 to 10-25

- boot, 10-12, 10-21, 10-24
- console, 3-5, 10-6 to 10-7, 10-24
- console commands used with, 10-24
- deleting values of, 10-23
- haltaction, 3-8, 10-25
- more, 10-25
- setting values of, 10-22



## Environment variables (Cont.)

showing values of, 10-21

testaction, 3-6, 10-25

to or examine (console command), 10-18 to 10-19

## Equipment specifications

BA42 storage expansion box, A-11

LK401-AA keyboard, A-3 to A-4

LK421-AA keyboard, A-5 to A-6

RRD42 optical compact disc drive, A-27

RX23 diskette drive, A-28 to A-29

RX33 diskette drive, A-30 to A-31

RZ55 hard disk drive, A-12 to A-13

RZ56 SCSI hard disk drive, A-14 to A-15

RZ57 SCSI hard disk drive, A-16 to A-17

RZ58 SCSI hard disk drive, A-18 to A-19

system unit, A-2

TK50Z tape drive, A-20 to A-21

TLZ04 cassette tape drive, A-26

TZ30 tape drive, A-22 to A-23

TZK10 QIC tape drive, A-24 to A-25

VSXXX-AB tablet, A-9 to A-10

VSXXX-GA mouse, A-7 to A-8

to or examine (console command), 10-19

## Ethernet

connecting to Ethernet networks, 6-1 to 6-17

connector on system unit, 1-5 installing, 6-7 to 6-17

ThickWire Ethernet cable, 6-8 to 6-10

ThinWire Ethernet adapter, 6-11 to 6-14

twisted-pair Ethernet adapter, 6-15 to 6-17

sliding lock on connectors, 6-3

station addresses, 6-6

ThickWire loopback connector, 1-7, 6-2 to 6-3

troubleshooting, 11-13

TURBOchannel option module, 8-5

## Expansion boxes

See BA42 expansion box, External storage devices, TURBOchannel extender (TCE) unit

## External communications

See Communications devices

External storage devices, 5-1 to 5-19

See also Drives, Equipment specifications

in expansion boxes, 5-2, 5-19

installing, 5-1 to 5-13

removing, 5-19

rules for connecting, 5-3

testing, 5-17 to 5-18

troubleshooting, 11-10

## G

go (console command), 10-19

Graphics option module, 1-2, 3-4, 8-4

## H

haltaction (environment variable), 3-8, 10-25

Halt button, 1-5, 3-8

Hard disk drives

See Drives, Equipment specifications, External storage devices

Help (?) console command, 10-11

Humidity of worksite, 2-2

## I

Icons, 1-6

init (console command), 10-19

Input devices, 1-23 to 1-33

Interference, electrical and magnetic, 2-2

## K

### Keyboard

adjusting feet on, 1-29

cable assembly, 1-25

installing, 1-25 to 1-29

## Keyboard (Cont.)

- language selection for, 3-5
- models available, 1-23 to 1-24
- troubleshooting, 11-13

## L

Language menu, 3-5

LED display

- See* Diagnostic LED display

Lights

- LED display on system unit, 1-5
- power indicator on system unit, 1-3, 1-5

Loopback connectors

- summary of, C-6

ThickWire Ethernet, 1-7, 6-2 to 6-3

ls (console command), 10-20

## M

Memory modules

- description of, 8-3
- information in cnfg displays, 10-13, 10-16
- installing, 9-2 to 9-6
- removing, 9-8 to 9-10
- testing, 9-7 to 9-8
- troubleshooting, 11-9

Model codes, 10-13

Modes

- console, 10-2 to 10-3
- operating, 10-2
- privileged, 10-3
- restricted, 10-3

Module codes, 10-13, 10-14 to 10-15

Monitors

- color, 1-12 to 1-13
- gray-scale, 1-14 to 1-15
- installing, 1-9 to 1-22
- monochrome, 1-16 to 1-17
- multiple, 1-17, 3-4
- on/off switches, 1-9, 1-10
- positioning, 1-10
- supplying power to, 1-18 to 1-22

Monitors (Cont.)

- troubleshooting, 11-11 to 11-13
  - video cables for, 1-11 to 1-17
  - more (environment variable), 10-25
- Mouse, 1-30 to 1-31
- Moving the workstation, 4-2

## N

Nameplate

- replacing, 9-17

Networks

- See* Ethernet

Nonvolatile random-access memory

- (NVRAM) module
- description of, 8-4
- installing and removing, 9-11
- testing, 9-11 to 9-13
- troubleshooting, 11-9, 11-22

## O

Optical compact disc drives

- See* Drives, Equipment specifications, External storage devices

Option slots

- See under* Slot numbers, TURBOchannel

## P

Part numbers

- adapters, connectors, and terminators, B-4
  - basic components, B-2
  - ords, cables, and connectors, B-3
  - hardware documentation, B-5
  - software documentation, B-4
  - user-replaceable modules, B-2
- Passwd (console command), 3-4
- Password
- See* Console password
- Pin assignments
- See* Connector pin assignments
- Pointing devices, 1-30 to 1-33

## Pointing devices (Cont.)

troubleshooting, 11-14

## Power cables and cords

monitor, 1-18 to 1-22

system unit, 1-8

Power indicator light, 1-3, 1-5

## Powering down

*See* Turning off the workstation

## Powering up

*See* Turning on the workstation

Power requirements for the workstation,  
2-3

Power supply, 8-5

## Power switch

monitor, 1-9

system unit, 1-5

printenv (console command), 10-21

## Printers

installing, 7-2

troubleshooting, 11-17

## Problems

*See* Troubleshooting

Product ID, 10-16

## Prompts

console >>, 3-4, 10-3

restricted R>, 10-3

## R

restart (console command), 10-21

## S

script (console command), 10-22

## Scripts

displaying contents of, 10-12

running scripts with the sh command,  
10-22 to 10-23

writing, 10-22

## SCSI

cables, 5-3, 5-14

connector on system unit, 1-2, 1-5

connectors in TURBOchannel slots,  
5-2

device code, 10-16

## SCSI (Cont.)

drives, 5-2, 5-3

drive terminator, 5-3, 5-12

## ID numbers

checking, 5-15

setting, 5-16

within a chain of devices, 5-3,  
5-4, 5-15

information in cnfg displays, 10-16

TURBOchannel option module, 8-4

## Self-tests

interpreting error messages, 11-19  
to 11-24

power-up self-test, 3-6 to 3-7

system self-test, 3-7

## Serial communications

*See* Communications

setenv (console command), 10-22

sh or shell (console command), 10-22  
to 10-23

Site requirements, 2-2 to 2-3

## Sliding lock

on Ethernet connectors, 6-3

## Slot numbers

base system slot, 10-13

configuration tests and, 3-7, 10-13

TURBOchannel, 1-5

Static electricity, 2-2, 8-8

*See also* Antistatic wrist strap

Stopping the workstation, 3-8

*See also* Turning off the workstation

## Storage expansion boxes

*See* External storage devices, BA42  
expansion box, TURBOchannel  
extender (TCE) unit

Supplies, storage of, 2-3

System console, 10-2

*See also* Console mode

monitor as system console, 10-7

terminal as system console, 10-4 to  
10-6

## System unit

antistatic precautions for working  
inside of, 8-8

## System unit (Cont.)

- connectors, 1-4
- cooling vents, 1-6
- cover, 8-6 to 8-7
- description of, 1-2 to 1-6
- general view of inside, 9-4
- installing, 1-6 to 1-8
- main parts of, 8-2 to 8-5
- power cord, 1-8

## T

Tablet, 1-30 to 1-31

Tape drives

- See* Drives, Equipment specifications,  
External storage devices

T-connector, 6-13

Temperature of worksite, 2-2

Terminals, 10-4 to 10-6

Terminators

- Ethernet loopback connector, 6-2 to  
6-3

- SCSI drive, 5-3, 5-12

- ThinWire Ethernet, 6-14

testaction (environment variable), 3-6,  
10-25

Testing

- See also* Self-tests, Troubleshooting  
CPU module, 9-18

- external storage devices, 5-17 to  
5-18

- memory modules, 9-7 to 9-8, 10-13

- NVRAM module, 9-11 to 9-13

- the workstation, 3-6 to 3-7

- the workstation configuration, 3-7

ThickWire Ethernet

- See* Ethernet

ThinWire Ethernet

- See* Ethernet, installing ThinWire  
Ethernet adapter

t or test (console command), 10-23

Troubleshooting, 11-1 to 11-24

- See also* Testing

- colors are inappropriate, 11-12

## Troubleshooting (Cont.)

- common problems, 11-9 to 11-18

- communications devices, 11-18

- component connections, 11-9 to  
11-18

- components functioning, 11-18 to  
11-24

- contacting your Customer Support  
Center, 11-3

- cursor does not move properly, 11-14

- diagnostic LED display, 11-4

- error message log, 10-19

- external drives, 11-10

- initializing the workstation, 11-4

- interpreting self-test messages,  
11-19 to 11-24

- keyboard does not seem to work,  
11-13

- memory size incorrect, 11-9

- networks, 11-13

- NVRAM module, 11-9, 11-22

- pointing devices, 11-14

- printers, 11-17

- screen is blank or distorted, 11-11,  
11-13

- self-test error messages for base  
system slot, 11-20 to 11-24

- system unit, 3-5

- TK50Z tape drive, 11-17

- worksystem software, 11-15 to  
11-16

TURBOchannel

- option modules, 1-2, 8-4 to 8-5,  
9-19

- option slots, 1-2, 1-5

- wide option modules, 8-5

TURBOchannel extender (TCE) unit,  
5-2 to 5-13, 8-5

Turning off the workstation, 3-9

Turning on the workstation, 3-2 to 3-5

Twisted-pair Ethernet

- See* Ethernet, installing twisted-pair  
Ethernet adapter

## U

ULTRIX worksystem software  
  console command arguments and, 10-9  
  entering console mode from, 10-3, 10-25  
  error messages from, 10-4  
  restarting, 10-10, 10-21, 10-25  
  starting (booting), 10-21, 10-25  
  troubleshooting, 11-15 to 11-16  
unsetenv (console command), 10-23

## V

Video cables  
  color, 1-11, 1-12  
  gray-scale, 1-11, 1-14  
  monochrome, 1-11, 1-16  
Video connector, 1-9  
Voltage requirements

*See* Power requirements for the workstation

## W

### Workstation

*See also* System unit  
  adjusting for comfort, 1-33  
  configuration display, 3-7, 10-13 to 10-17  
  dismantling and moving, 4-2  
  main components of, 1-1 to 1-33  
  stopping, 3-8  
  testing, 3-6 to 3-7  
  total installed memory, 10-13  
  turning off, 3-9  
  turning on, 3-2 to 3-5

### Worksystem software

*See* ULTRIX worksystem software